

Rexroth

Tightening Systems





4	FACTORY OF THE FUTURE – CONNECTED TIGHTENING TECHNOLOGY	110	CONTROL AND POWER ELECTRONICS
		112	Compact system
		118	Modular system
		120	System box
		122	Card rack
		129	Accessories for control and power electronics
		130	Control cabinets

6	TIGHTENING SYSTEMS AT A GLANCE	132	INTERFACE MODULES
----------	---------------------------------------	------------	--------------------------

8	TIGHTENING SPINDLES	136	CABLES
12	Tightening spindles size 2		
28	Tightening spindles size 3		
48	Tightening spindles size 4		
68	Tightening spindles size 5		
76	Accessories for tightening spindles		

78	CUSTOMIZED SOLUTIONS AND PROJECTS	144	SOFTWARE AND OPERATING SYSTEM
-----------	--	------------	--------------------------------------

82	ERGOSPIN HAND-HELD NUTRUNNERS	150	OPERATOR GUIDANCE SYSTEM
94	Accessories for hand-held nutrunners ErgoSpin / CC-ErgoSpin		
99	Angle compensation function		

100	NEXO – INTELLIGENT CORDLESS NUTRUNNERS	152	SERVICE
104	Nexo – angle heads		
105	Nexo – accessories and extensions		
109	NEXO-OS – browser-based operating system		

		154	ASSEMBLY TECHNOLOGY AT A GLANCE
--	--	------------	--

		158	RATING OF A TIGHTENING CONNECTION
--	--	------------	--

		159	CLAMPING FORCE TABLE
--	--	------------	-----------------------------

		160	GLOSSARY
--	--	------------	-----------------

**WE MOVE.
YOU WIN.**

Factory of the Future – connected tightening technology

The factory of the future. What will it look like? Bosch Rexroth has very clear ideas about it. They are based on experiences with networking more than 270 plants of the Bosch Group and numerous projects with other companies. In the factory of the future, only the floor, the walls and the roof cannot be changed. Machines, automation topologies and assembly lines adapt to new mobile requirements and constantly form new production lines. They communicate wirelessly with each other and with higher-level systems via open protocol that confirm to open standards.



How do you benefit from this? You increase transparency in mass production and continuously reduce costs. In a variety of production processes, you can produce the economically smallest quantities down to batch size 1. The best thing is that Bosch Rexroth's intelligent tightening technology is opening the path to the factory of the future for you today. It can already be integrated quickly, using wireless communication and common standards in networked environments.

Factory of the Future

Now. Next. Beyond.

MAXIMUM FLEXIBILITY

In the factory of the future, machines do not have cabinets and can be combined with minimum effort to form new production units at any time. They exchange wireless information, which can be processed optionally in machines, on production lines or in clouds – all prerequisites which the Nexo cordless nutrunner already fulfills. With Nexo, the controller is directly integrated in the nutrunner. It controls all processes and compares actual values with nominal values. The nutrunners communicate wirelessly via common protocols with higher-level systems and the browser-based operating software can be called up with any end devices. With the use of scanners, Nexo cordless nutrunners accommodate smallest quantities down to batch size 1 with ease.

DIGITIZED VALUE STREAM

Fully link your value stream with process data to the virtual world of information technology! The **Production Performance Manager** is an information and assessment system that systematically improves your production. The integrated **Process Quality Module** records and visualizes all tightening process data. This allows you to monitor your processes continuously, diagnose errors and detect wear before it causes a production stop.

The software supports you with real-time evaluations of all relevant production data to allow you to identify process risks very early and react more quickly to process errors. The result is complete transparency – the prerequisite for continuous improvement through to new business models which no longer require you to invest in operating resources. In fact, in the future you will only pay for value-add – for example correct and documented tightening processes. Let's talk about this!

Our experts actively advise and support you so that you're prepared to rise to the challenges of the factory of the future. Get in touch with us via factoryofthefuture@boschrexroth.com

Clever, flexible, secure: Rexroth tightening technology

Rexroth offers precise tightening technology – tools, control systems and the corresponding accessories – for all key tightening tasks in a wide variety of industries: from the intelligent cordless nutrunner, the ergonomic hand-held nutrunner, to the versatile tightening spindles and even the fully automatable tightening system.

Ethernet-based data/
control protocols

- ▶ FTP protocols
- ▶ Open protocol
- ▶ VW-XML protocol
- ▶ IPM protocol
- ▶ CAQTNG
- ▶ PLUS protocol
- ▶ QDA protocol
- ▶ HTTP

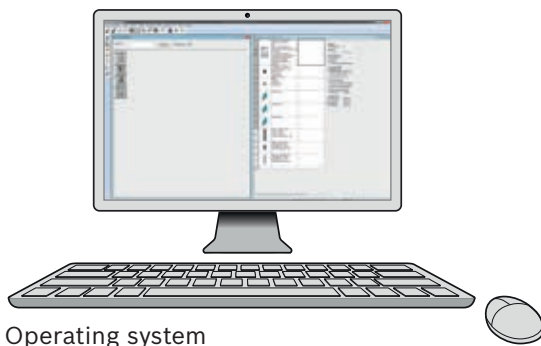

Operating system

ADVANTAGES OF THE SOFTWARE

- ▶ All in one software package includes an extensive and user-friendly statistics package.
- ▶ System installation and programming of individual tightening tasks is done via convenient, icon-supported tools.
- ▶ 180 curves are available for an analysis of the tightening joints.
- ▶ Step by step programming structure allows for a logical breakdown of the tightening rundown and easy identification where an issue occurs in the rundown process.
- ▶ Individual solutions can be found under "Customized solutions" on page 78.

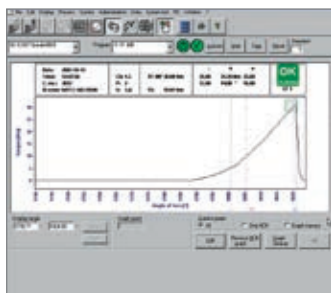

Graph

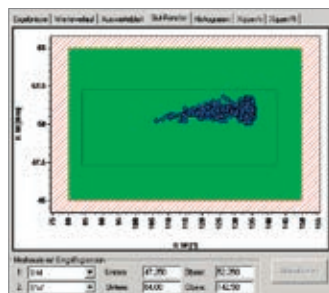

Good range window

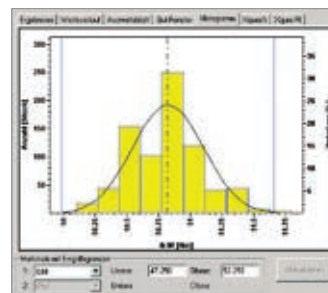

Histogram

Time	Result	State	Time	State	Program
00:00:00	0.00	Start	00:00:00	Start	1
00:00:01	0.00	Start	00:00:01	Start	1
00:00:02	0.00	Start	00:00:02	Start	1
00:00:03	0.00	Start	00:00:03	Start	1
00:00:04	0.00	Start	00:00:04	Start	1
00:00:05	0.00	Start	00:00:05	Start	1
00:00:06	0.00	Start	00:00:06	Start	1
00:00:07	0.00	Start	00:00:07	Start	1
00:00:08	0.00	Start	00:00:08	Start	1
00:00:09	0.00	Start	00:00:09	Start	1
00:00:10	0.00	Start	00:00:10	Start	1
00:00:11	0.00	Start	00:00:11	Start	1
00:00:12	0.00	Start	00:00:12	Start	1
00:00:13	0.00	Start	00:00:13	Start	1
00:00:14	0.00	Start	00:00:14	Start	1
00:00:15	0.00	Start	00:00:15	Start	1
00:00:16	0.00	Start	00:00:16	Start	1
00:00:17	0.00	Start	00:00:17	Start	1
00:00:18	0.00	Start	00:00:18	Start	1
00:00:19	0.00	Start	00:00:19	Start	1
00:00:20	0.00	Start	00:00:20	Start	1
00:00:21	0.00	Start	00:00:21	Start	1
00:00:22	0.00	Start	00:00:22	Start	1
00:00:23	0.00	Start	00:00:23	Start	1
00:00:24	0.00	Start	00:00:24	Start	1
00:00:25	0.00	Start	00:00:25	Start	1
00:00:26	0.00	Start	00:00:26	Start	1
00:00:27	0.00	Start	00:00:27	Start	1
00:00:28	0.00	Start	00:00:28	Start	1
00:00:29	0.00	Start	00:00:29	Start	1
00:00:30	0.00	Start	00:00:30	Start	1
00:00:31	0.00	Start	00:00:31	Start	1
00:00:32	0.00	Start	00:00:32	Start	1
00:00:33	0.00	Start	00:00:33	Start	1
00:00:34	0.00	Start	00:00:34	Start	1
00:00:35	0.00	Start	00:00:35	Start	1
00:00:36	0.00	Start	00:00:36	Start	1
00:00:37	0.00	Start	00:00:37	Start	1
00:00:38	0.00	Start	00:00:38	Start	1
00:00:39	0.00	Start	00:00:39	Start	1
00:00:40	0.00	Start	00:00:40	Start	1
00:00:41	0.00	Start	00:00:41	Start	1
00:00:42	0.00	Start	00:00:42	Start	1
00:00:43	0.00	Start	00:00:43	Start	1
00:00:44	0.00	Start	00:00:44	Start	1
00:00:45	0.00	Start	00:00:45	Start	1
00:00:46	0.00	Start	00:00:46	Start	1
00:00:47	0.00	Start	00:00:47	Start	1
00:00:48	0.00	Start	00:00:48	Start	1
00:00:49	0.00	Start	00:00:49	Start	1
00:00:50	0.00	Start	00:00:50	Start	1
00:00:51	0.00	Start	00:00:51	Start	1
00:00:52	0.00	Start	00:00:52	Start	1
00:00:53	0.00	Start	00:00:53	Start	1
00:00:54	0.00	Start	00:00:54	Start	1
00:00:55	0.00	Start	00:00:55	Start	1
00:00:56	0.00	Start	00:00:56	Start	1
00:00:57	0.00	Start	00:00:57	Start	1
00:00:58	0.00	Start	00:00:58	Start	1
00:00:59	0.00	Start	00:00:59	Start	1
00:01:00	0.00	Start	00:01:00	Start	1

Result window

Fieldbus connection via
Rexroth interface modules

- ▶ PROFIBUS DP
- ▶ DeviceNet
- ▶ PROFINET IO
- ▶ Modbus TCP
- ▶ Ethernet/IP
- ▶ EtherCat

Production Performance Manager
with Process Quality Module

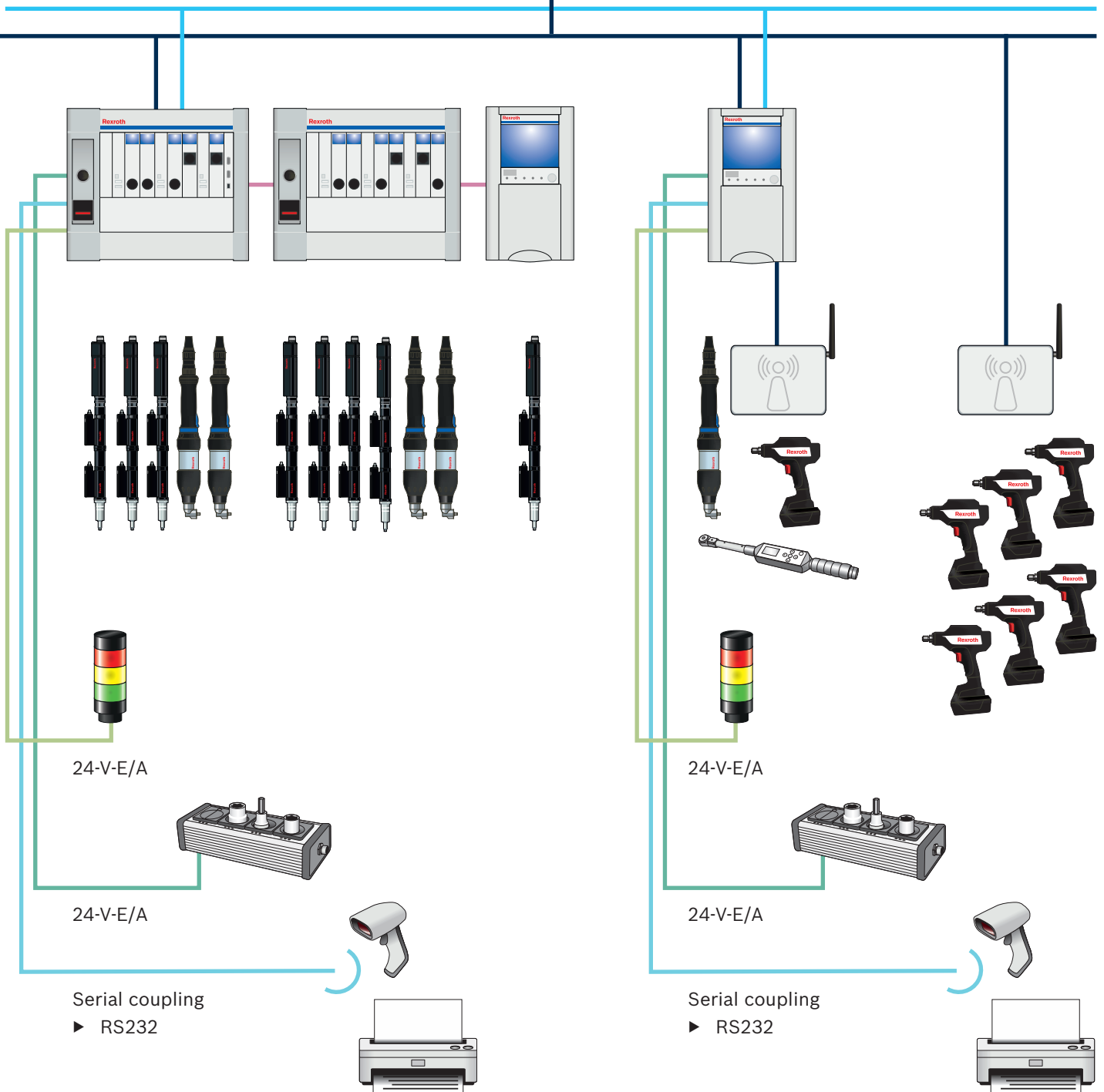

Tightening spindles 0.6–1,000 Nm



The modular construction of Rexroth tightening spindles enables a very precise adjustment to the tightening task at hand. Conformity with the VDI standard ensures that your tightening connections meet the highest safety requirements. The versatility of Rexroth tightening spindles not only guarantees safety but also a perfect design customized to your needs.



- ▶ Modular design, ideal adjustment to tightening case
- ▶ Maintenance-free for 1 million full-load cycles, long service life
- ▶ Process reliability and minimal waste thanks to real redundancy measurement
- ▶ Digital measurement transfer, maximum precision
- ▶ Largest working range
- ▶ Assured accuracy within the working range according to VDI/VDE 2647

Maximum flexibility in tightening spindle configuration – here are just some of the many options:



TIGHTENING SPINDLE WITH ANGLE HEAD

- ▶ For high accessibility
- ▶ Also available with integrated measurement transducer



TIGHTENING SPINDLE WITH OFF SET OUTPUT DRIVE

- ▶ For side-by-side arrangement with small center-to-center distances
- ▶ Also available with integrated measurement transducer



TIGHTENING SPINDLE WITH TRANSVERSE GEARBOX

- ▶ Compact length
- ▶ Available for all sizes



TIGHTENING SPINDLE WITH FEED OUTPUT DRIVE

- ▶ Integrated feed movement
- ▶ For use in connection with automatic bolt supply

Configure your tightening spindle

NUMEROUS OPTIONS

With a working range between 0.6 and 1,000 Nm (higher torques on request) and a choice between straight output drives, offset output drives, feed output drives, and angle heads – with Rexroth components you can configure a tightening spindle that is customized to your individual requirements.

We offer the offset output drive and angle head also with integrated measurement transducer. You can decide between having just one measurement transducer or working with an additional second redundant one. We can provide the optimum spindle components for any task. Why not find the perfect tightening spindle for your tightening connection?

Depending on the size, the actual components may differ from those in the illustration.

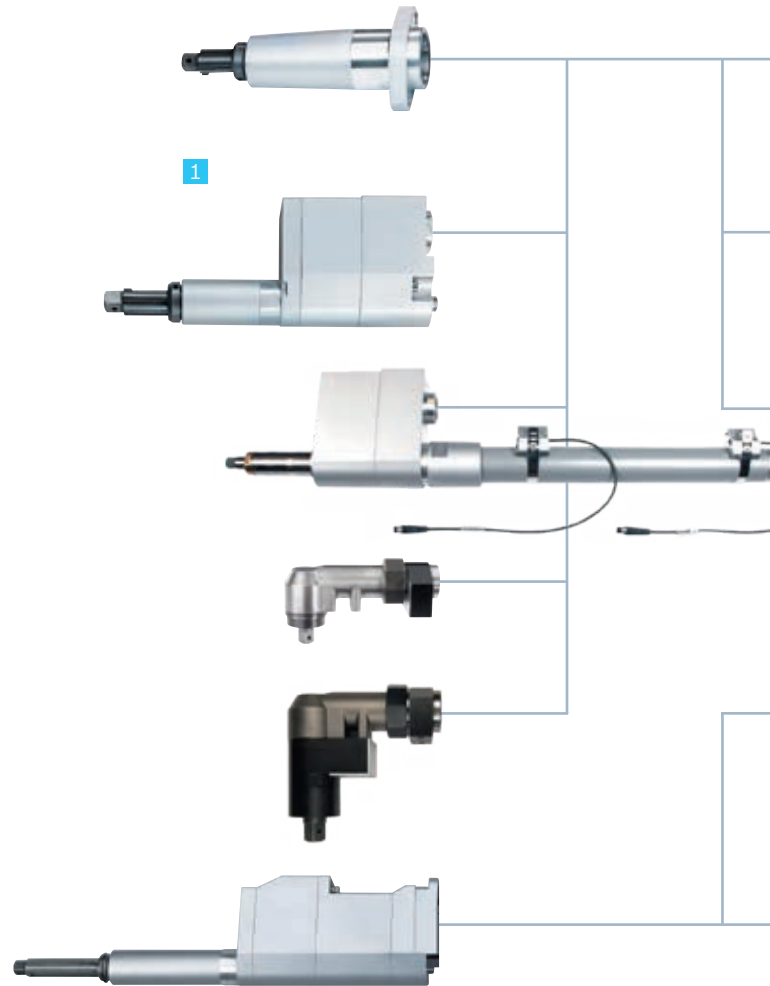

1 OUTPUT DRIVES

- ▶ The suitable output drive for every tightening position
- ▶ Special output drives for increased transverse forces, e.g. for wheel nutrunners, on request

2 ADAPTER A

- ▶ Connects planetary gearbox and output drive when operating without a measurement transducer

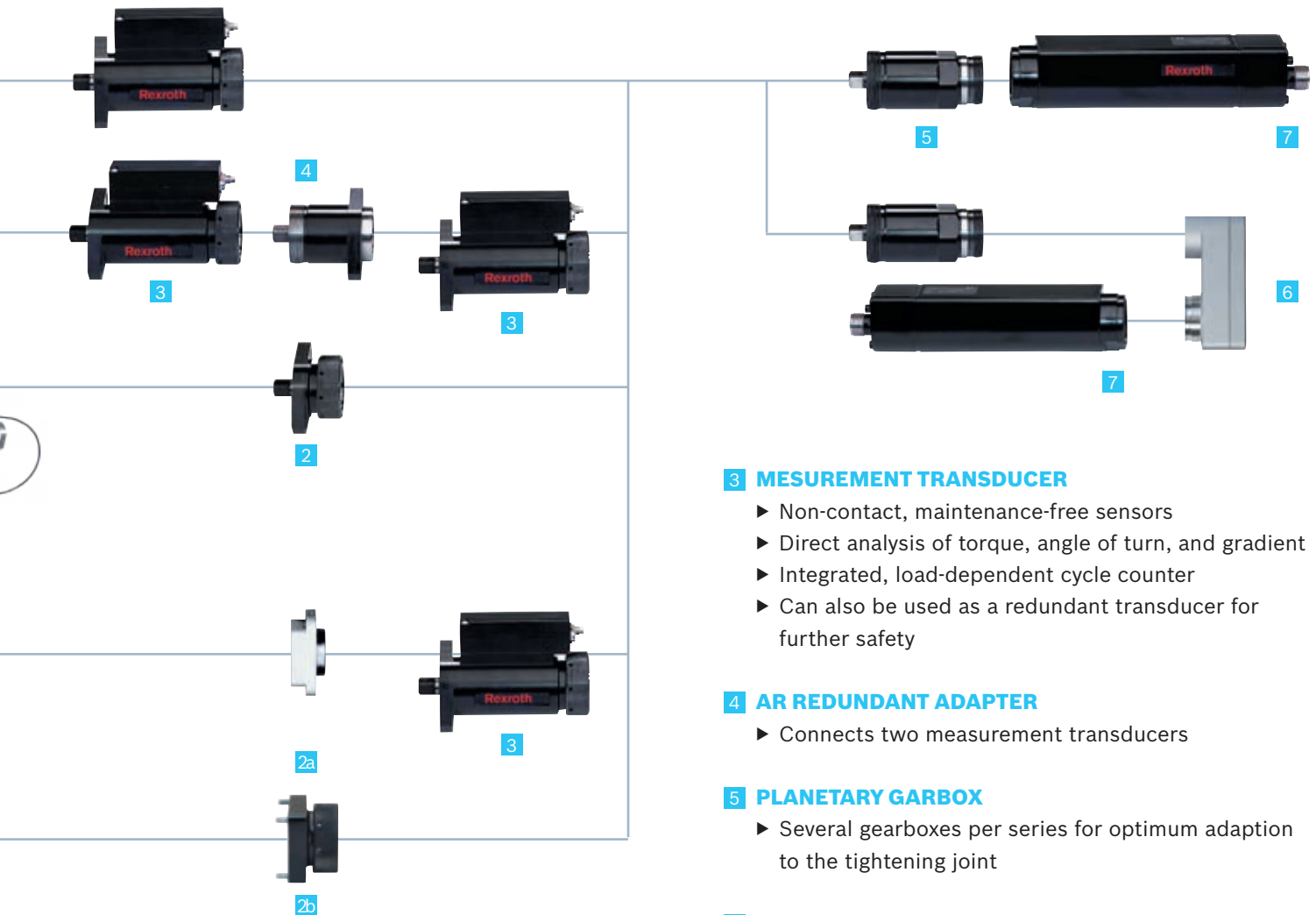

2a AVR REDUNDANT ADAPTER

- ▶ Connects an offset output drive with integrated transducer to a measurement transducer

2b AVG ADAPTER

- ▶ Connects an offset output drive with integrated transducer to a planetary gearbox when operating without a redundant measurement transducer

3 MESUREMENT TRANSDUCER

- ▶ Non-contact, maintenance-free sensors
- ▶ Direct analysis of torque, angle of turn, and gradient
- ▶ Integrated, load-dependent cycle counter
- ▶ Can also be used as a redundant transducer for further safety

4 AR REDUNDANT ADAPTER

- ▶ Connects two measurement transducers

5 PLANETARY GEARBOX

- ▶ Several gearboxes per series for optimum adaption to the tightening joint

6 TRANSVERSE GEARBOX

- ▶ Reduction of installation length

7 EC MOTOR

- ▶ Reliable
- ▶ Short tightening times
- ▶ Excellent dynamics
- ▶ High RPM
- ▶ Side-by-side arrangement due to small outer dimensions
- ▶ High density and power efficiency

Tightening spindles size 2

Spindle bearing



- ▶ Working range 0.6 – 10 Nm
- ▶ Max. output drive speed 1,000 rpm

Depending on the size, the actual components may differ from those in the illustration.

FEATURES

- ▶ Various lengths with axial compensator
- ▶ Standard tool mounts
- ▶ Maximum efficiency
- ▶ Maintenance-free for 1 million full-load cycles





Tightening spindle		Spindle bearing				Measurement transducer	Planetary gearbox	EC motor
Working range*	Max. output drive speed	Range of spring mm/ max. spring force N	Tool mount	Code	Order no.	Code / Order no.	Code / Order no.	Code / Order no.
Nm	rpm							
0.6–5.6	1,000	20/34.1	1/4" square drive	2GA82	0608800077	2DMC006 0608820110	2GE19 0608720043	EC302 0608701016
			1/4" quick-change chuck	2GB82	0608800078			
				2GB82F73	0608800085			
	780	20/34.1	1/4" square drive	2GA82	0608800077		2GE26 0608720038	
			1/4" quick-change chuck	2GB82	0608800078			
				2GB82F73	0608800085			
1.2–10	1,000	20/34.1	1/4" square drive	2GA82	0608800077	2DMC012 0608820111	2GE19 0608720043	
			1/4" quick-change chuck	2GB82	0608800078			
				2GB82F73	0608800085			
	780	20/34.1	1/4" square drive	2GA82	0608800077		2GE26 0608720038	
			1/4" quick-change chuck	2GB82	0608800078			
				2GB82F73	0608800085			

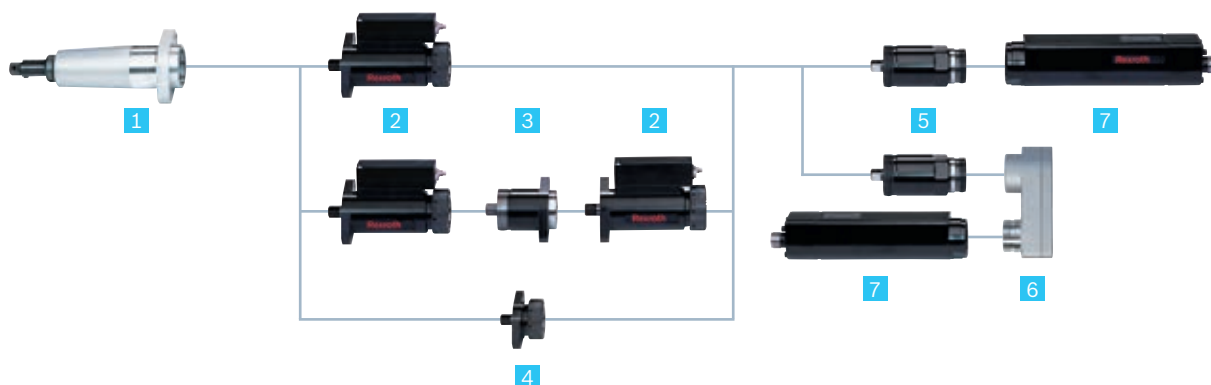

* The accuracy within the working range according to VDI/VDE 2647 is $\pm 2\%$ over 6 s.

Note: You can find component dimensions and 3D/CAD data on the Internet at www.boschrexroth.com/tightening





Spindle bearing size 2 – components



1 Spindle bearing 	Code	2GA82	2GB82	2GB82F73	
	Order no.	0 608 800 077	0 608 800 078	0 608 800 085	
	Max. torque	Nm	10	10	10
	Range of spring	mm	20	20	20
	Spring force	N	16–34	16–34	22–73
	Reduction		1	1	1
	Avg. efficiency		1	1	1
	Length A	mm	82	82	82
	Installation length	mm	90	90	90
Weight	kg	0.2	0.2	0.2	
2 Measurement transducer 	Code	2DMC006	2DMC012		
	Order no.	0 608 820 110	0 608 820 111	You can configure your tightening spindle with a redundant measurement transducer from the same type. Connect both measurement transducers with the redundant adapter. For measurement transducer cables, see page 140.	
	Nominal torque	Nm	6	12	
	Reduction		1	1	
	Avg. efficiency		1	1	
	Installation length	mm	118.5	118.5	
Weight	kg	0.55	0.55		
3 Redundanzadapter 	Code	2AR			
	Order no.	0 608 810 020		When configuring with a redundant measurement transducer, the adapter connects both measurement transducers.	
	Reduction		1		
	Avg. efficiency		1		
	Installation length	mm	50		
Weight	kg	0.3			
4 Adapter 	Code	2A			
	Order no.	0 608 810 024		When configuring without a measurement transducer, the adapter connects the output drive and the planetary gearbox.	
	Reduction		1		
	Avg. efficiency		1		
	Installation length	mm	30		
Weight	kg	0.4			

5 Planetary gearbox 	Code	2GE19	2GE26	
	Order no.	0608720043	0608720038	
	Reduction	18.9	25.5	
	Avg. efficiency	0.93	0.9	
	Installation length	mm	50.9	50.9
	Weight	kg	0.4	0.4
6 Transverse gearbox 	Code	2ULG		
	Order no.	0608810054		
	Reduction	1		
	Avg. efficiency	0.95		
	Installation length	mm	28.3	The transverse gearbox shortens the length of your tightening spindle by the installation length of the EC motor plus the installation length of the transverse gearbox.
	Weight	kg	0.4	
7 EC motor 	Code	EC302		
	Order no.	0608701016		
	Installation length	mm	197	
	Weight	kg	0.72	

Side-by-side arrangement of tightening spindles (center-to-center distance)

Number of tightening spindles	2	3	4	5	6	
						
Min. circle diameter- $\varnothing d_{\min}$ mm	2G...	35	40	55	66	74

Tightening spindles size 2

Offset output drive



- ▶ Working range 0.6 – 10 Nm
- ▶ Max. output drive speed 1,000 rpm

Depending on the size, the actual components may differ from those in the illustration.

FEATURES

- ▶ For tight hole templates, side-by-side arrangement with small center-to-center distances
- ▶ Standard tool mounts
- ▶ Maintenance-free for 1 million full-load cycles





Tightening spindle		Offset output drive				Measurement transducer	Planetary gearbox	EC motor
Working range	Max. output drive speed	Range of spring	Tool mount	Code	Order no.	Code/Order no.	Code/Order no.	Code/Order no.
Nm	rpm	mm						
0.6*–5.1	1,000	20	1/4" square drive	2VNA82	0608800607	2DMC006 0608820110	2GE19 0608720043	EC302 0608701016
			1/4" quick-change chuck	2VNB82	0608800608			
	780	20	1/4" square drive	2VNA82	0608800607		2GE26 0608720038	
			1/4" quick-change chuck	2VNB82	0608800608			
1.2*–10	1,000	20	1/4" square drive	2VNA82	0608800607	2DMC012 0608820111	2GE19 0608720043	
			1/4" quick-change chuck	2VNB82	0608800608			
	780	20	1/4" square drive	2VNA82	0608800607		2GE26 0608720038	
			1/4" quick-change chuck	2VNB82	0608800608			

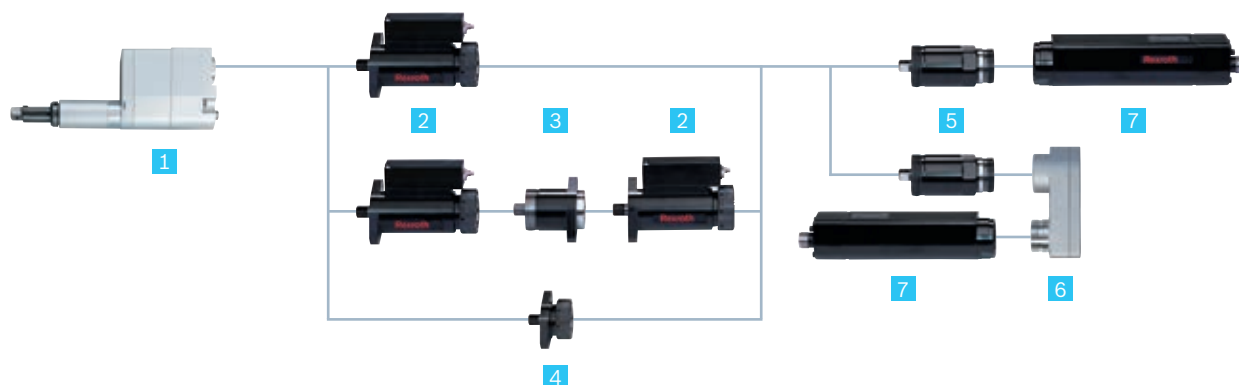

* Depending on the tolerance limits, position-based MCT required





Note: You can find component dimensions and 3D/CAD data on the Internet at www.boschrexroth.com/tightening

Offset output drive size 2 – components



1 Offset output drive 	Code	2VNA82	2VNB82		
	Order no.	0 608 800 607	0 608 800 608		
	Max. torque	Nm	10	10	
	Range of spring	mm	20	20	
	Spring force	N	16–34	16–34	
	Reduction		1	1	
	Avg. efficiency		0.9	0.9	
	Length A	mm	82	82	
	Installation length	mm	153	153	
Weight	kg	0.6	0.6		
2 Measurement transducer 	Code	2DMC006	2DMC012		
	Order no.	0 608 820 110	0 608 820 111	You can configure your tightening spindle with a redundant measurement transducer from the same type. Connect both measurement transducers with the redundant adapter. For measurement transducer cables, see page 140.	
	Nominal torque	Nm	6	12	
	Reduction		1	1	
	Avg. efficiency		1	1	
	Installation length	mm	118.5	118.5	
Weight	kg	0.55	0.55		
3 Redundant adapter 	Code	2AR			
	Order no.	0 608 810 020		When configuring with a redundant measurement transducer, the adapter connects both measurement transducers.	
	Reduction		1		
	Avg. efficiency		1		
	Installation length	mm	50		
Weight	kg	0.3			
4 Adapter 	Code	2A			
	Order no.	0 608 810 024		When configuring without a measurement transducer, the adapter connects the output drive and the planetary gearbox.	
	Reduction		1		
	Avg. efficiency		1		
	Installation length	mm	30		
Weight	kg	0.4			

5 Planetary gearbox 	Code	2GE19	2GE26
	Order no.	0608720043	0608720038
	Reduction	18.9	25.5
	Avg. efficiency	0.93	0.9
	Installation length	mm 50.9	50.9
	Weight	kg 0.4	0.4
6 Transverse gearbox 	Code	2ULG	
	Order no.	0608810054	The transverse gearbox shortens the length of your tightening spindle by the installation length of the EC motor plus the installation length of the transverse gearbox.
	Reduction	1	
	Avg. efficiency	0.95	
	Installation length	mm 28.3	
	Weight	kg 0.4	
7 EC motor 	Code	EC302	
	Order no.	0608701016	
	Installation length	mm 197	
	Weight	kg 0.72	

Side-by-side arrangement of tightening spindles (center-to-center distance)						
Number of tightening spindles	2	3	4	5	6	
						
Min. circle diameter- $\varnothing d_{\min}$ mm	2VN...82	23	27	33	41	52

Tightening spindles size 2 Angle head



- ▶ Working range 2.2 – 11 Nm
- ▶ Max. output drive speed 1,000 rpm

Depending on the size, the actual components may differ from those in the illustration.

MERKMALE

- ▶ For restricted accessibility
- ▶ Precision tothing for high torque accuracy
- ▶ Incremental positioning (45° increments)
- ▶ Integrated fastening flanges

Tightening spindle		Angle head			Measurement transducer	Planetary gearbox	EC motor
Working range Nm	Max. output drive speed rpm	Tool mount	Code	Order no.	Code/Order no.	Code/Order no.	Code/Order no.
2.2–5.6	1,000	1/4" square drive	2W11	0608810041	2DMC006 0608820110	2GE19 0608720043	EC302 0608701016
	740	1/4" square drive	2W11	0608810041		2GE26 0608720038	
2.2–11	1,000	1/4" square drive	2W11	0608810041	2DMC012 0608820111	2GE19 0608720043	
	740	1/4" square drive	2W11	0608810041		2GE26 0608720038	

Note: You can find component dimensions and 3D/CAD data on the Internet at www.boschrexroth.com/tightening

ANGLE HEAD WITH SPINDLE BEARING

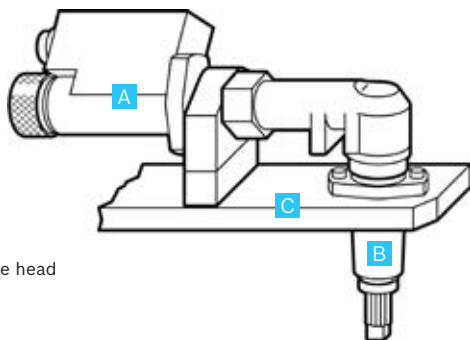

- A** Spindle with angle head
- B** Spindle bearing
- C** Mounting plate

AXIAL COMPENSATOR





To ensure troublefree operation, the angle head must always be operated with an output drive axial compensator, e.g. spindle bearing.

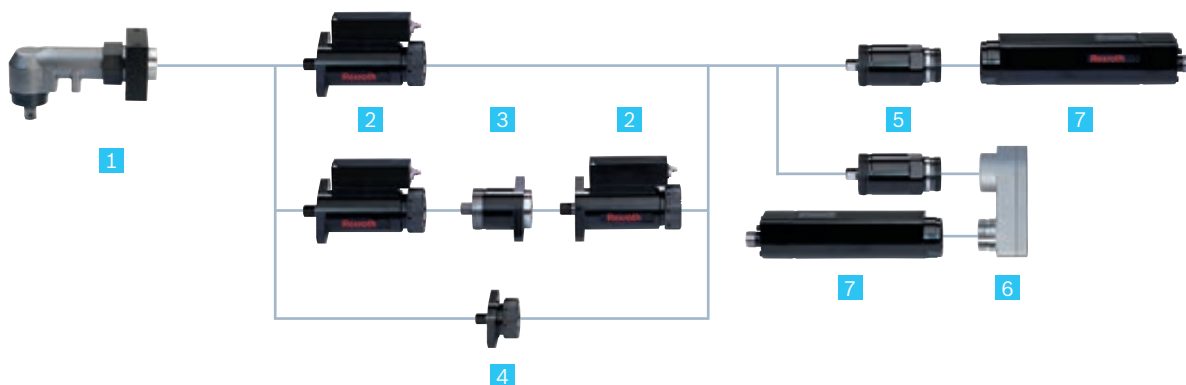

You can find more information in the planning instructions for angle heads in the Rexroth media directory at www.boschrexroth.com/mediadirectory.

For an output drive axial compensator, the following angle head/spindle bearing combination is possible:
2W011 (0608810041) – spindle bearing size 2 (page 14).





Angle head size 2 – components



1 Angle head 	Code	2W011			
	Order no.	0608810041			
	Max. torque	Nm	11		
	Reduction		1.05		
	Avg. efficiency		0.95		
	Installation length	mm	81.5		
	Weight	kg	0.7		
2 Measurement Transducer 	Code	2DMC006	2DMC012		
	Order no.	0608820110	0608820111	You can configure your tightening spindle with a redundant measurement transducer from the same type. Connect both measurement transducers with the redundant adapter. For measurement transducer cables, see page 140.	
	Nominal torque	Nm	6		12
	Reduction		1		1
	Avg. efficiency		1		1
	Installation length	mm	118.5		118.5
	Weight	kg	0.55		0.55
3 Redundant adapter 	Code	2AR			
	Order no.	0608810020		When configuring with a redundant measurement transducer, the adapter connects both measurement transducers	
	Reduction	1			
	Avg. efficiency	1			
	Installation length	mm	50		
	Weight	kg	0.3		
4 Adapter 	Code	2A			
	Order no.	0608810024		When configuring without a measurement transducer, the adapter connects the output drive and the planetary gearbox	
	Reduction	1			
	Avg. efficiency	1			
	Installation length	mm	30		
	Weight	kg	0.4		

5 Planetary gearbox 	Code	2GE19	2GE26	
	Order no.	0608720043	0608720038	
	Reduction	18.9	25.5	
	Avg. efficiency	0.93	0.9	
	Installation length	mm	50.9	50.9
	Weight	kg	0.4	0.4
6 Transverse gearbox 	Code	2ULG		
	Order no.	0608810054		
	Reduction	1		
	Avg. efficiency	0.95		
	Installation length	mm	28.3	
	Weight	kg	0.4	
<p>The transverse gearbox shortens the length of your tightening spindle by the installation length of the EC motor plus the installation length of the transverse gearbox.</p>				
7 EC motor 	Code	EC302		
	Order no.	0608701016		
	Installation length	mm	197	
	Weight	kg	0.72	

Side-by-side arrangement of tightening spindles (center-to-center distance)

Number of tightening spindles	2	3	4	5	6
					
Min. circle diameter- $\varnothing d_{\min}$ mm	2W011 26	30	36	44	52

Tightening spindles size 2

Feed output drive



- ▶ Working range 0.6 – 10 Nm
- ▶ Max. output drive speed 1,000 rpm

Depending on the size, the actual components may differ from those in the illustration.

FEATURES

- ▶ Integrated feed movement
- ▶ In connection with automatic bolt supply
- ▶ Standard tool mounts and compressed air connections
- ▶ Maintenance-free for 1 million full-load cycles





Tightening spindle		Feed output drive				Measurement transducer	Planetary gearbox	EC motor
Working range Nm	Max. output drive speed rpm	Stroke mm	Tool mount	Code	Bestell-Nr.	Code/ Order no.	Code/ Order no.	Code/ Order no.
0.6*–5.1	1,000	160	M6 outer thread	2S2M8	0608 800647	2DMC006 0608 820110	2GE19 0608 720043	EC302 0608 701016
	780	160	M6 outer thread	2S2M8	0608 800647		2GE26 0608 720038	
	1,000	160	1/4" square drive	2S1M8	0608 800646		2GE19 0608 720043	
	780	160	1/4" square drive	2S1M8	0608 800646		2GE26 0608 720038	
1.2*–7	1,000	160	M6 outer thread	2S2M8	0608 800647	2DMC012 0608 820111	2GE19 0608 720043	
	780	160	M6 outer thread	2S2M8	0608 800647		2GE26 0608 720038	
1.2*–10	1,000	160	1/4" square drive	2S1M8	0608 800646		2GE19 0608 720043	
	780	160	1/4" square drive	2S1M8	0608 800646		2GE26 0608 720038	

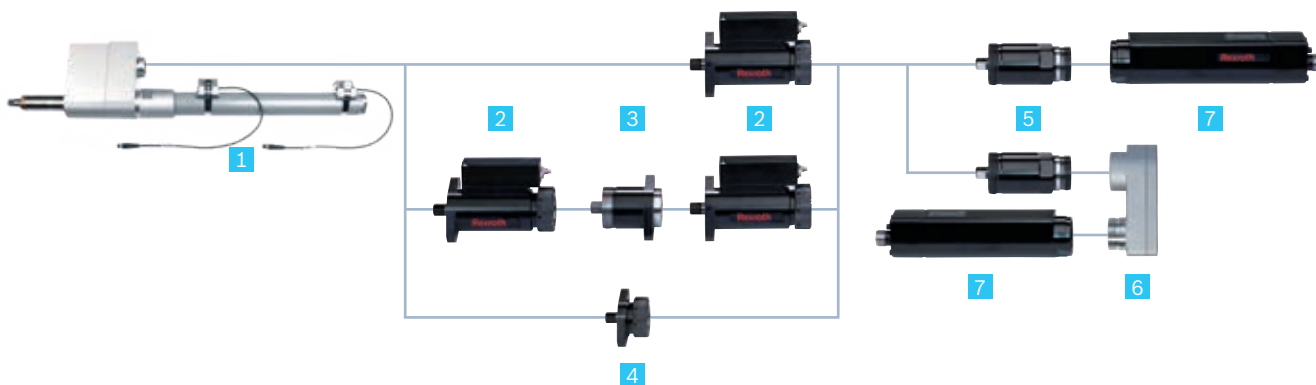

* Depending on the tolerance limits, position-based MCT required





Note: You can find component dimensions and 3D/CAD data on the Internet at www.boschrexroth.com/tightening

Feed output drive size 2 – components



1 Feed output drive	Code	2S1M8	2S2M8	
	Order no.	0 608 800 646	0 608 800 647	
	Max. torque	Nm 10	7	
	Stroke	mm 160	160	
	Max. air pressure	bar 4	4	
	Reduction	1	1	
	Avg. efficiency	0.93	0.93	
	Length A	mm 80	80	
	Installation length	mm 189.5	189.5	
	Weight	kg 2	2	
2 Measurement transducer	Code	2DMC006	2DMC012	
	Order no.	0 608 820 110	0 608 820 111	You can configure your tightening spindle with a redundant measurement transducer from the same type. Connect both measurement transducers with the redundant adapter. For measurement transducer cables, see page 140.
	Nominal torque	Nm 6	12	
	Reduction	1	1	
	Avg. efficiency	1	1	
	Installation length	mm 118.5	118.5	
	Weight	kg 0.55	0.55	
3 Redundant adapter	Code	2AR		
	Order no.	0 608 810 020		When configuring with a redundant measurement transducer, the adapter connects both measurement transducers.
	Reduction	1		
	Avg. efficiency	1		
	Installation length	mm 50		
	Weight	kg 0.3		
4 Adapter	Code	2A		
	Order no.	0 608 810 024		When configuring without a measurement transducer, the adapter connects the output drive and the planetary gearbox.
	Reduction	1		
	Avg. efficiency	1		
	Installation length	mm 30		
	Weight	kg 0.4		

5 Planetary gearbox 	Code	2GE19	2GE26
	Order no.	0608720043	0608720038
	Reduction	18.9	25.5
	Avg. efficiency	0.93	0.9
	Installation length	mm 50.9	50.9
	Weight	kg 0.4	0.4
6 Transverse gearbox 	Code	2ULG	
	Order no.	0608810054	The transverse gearbox shortens the length of your tightening spindle by the installation length of the EC motor plus the installation length of the transverse gearbox.
	Reduction	1	
	Avg. efficiency	0.95	
	Installation length	mm 28.3	
	Weight	kg 0.4	
7 EC motor 	Code	EC302	
Order no.	0608701016		
Installation length	mm 197		
Weight	kg 0.72		

Side-by-side arrangement of tightening spindles (center-to-center distance)					
Number of tightening spindle	2	3	4	5	6
					
Min. circle diameter- $\varnothing d_{\min}$ mm	2S... 33	38	46	55	65

Tightening spindles size 3

Spindle bearing



- ▶ Working range 1.7 – 56 Nm
- ▶ Max. output drive speed 740 rpm

Depending on the size, the actual components may differ from those in the illustration.

FEATURES

- ▶ Various lengths with axial compensator
- ▶ Standard tool mounts
- ▶ Maximum efficiency
- ▶ Maintenance-free for 1 million full-load cycles





Tightening spindle		Spindle bearing				Measurement transducer	Planetary gearbox	EC motor
Working range*	Max. output drive speed	Range of spring mm/ max. Spring force N	Tool mount	Code	Order no.	Code/ Order no.	Code/ Order no.	Code/ Order no.
Nm	rpm							
1.7–16	740	25/39	3/8" square drive	G1A102	0608800062	3DMC017 0608820112	3GE27 0608720053	EC303 0608701017
			1/4" quick-change chuck	G1B102	0608800063			
			3/8" square drive with centering pin	G1C102	0608800072			
		50/38	3/8" square drive	G2A152	0608800064			
			1/4" quick-change chuck	G2B152	0608800065			
			3/8" square drive with centering pin	G2C152	0608800073			
	295	25/39	3/8" square drive	G1A102	0608800062	3DMC060 0608820113	3GE27 0608720053	3GE67 0608720039
			1/4" quick-change chuck	G1B102	0608800063			
			3/8" square drive with centering pin	G1C102	0608800072			
		50/38	3/8" square drive	G2A152	0608800064			
			1/4" quick-change chuck	G2B152	0608800065			
			3/8" square drive with centering pin	G2C152	0608800073			
6–33	740	25/39	3/8" square drive	G1A102	0608800062	3DMC060 0608820113	3GE27 0608720053	3GE67 0608720039
			1/4" quick-change chuck	G1B102	0608800063			
			3/8" square drive with centering pin	G1C102	0608800072			
		50/38	3/8" square drive	G2A152	0608800064			
			1/4" quick-change chuck	G2B152	0608800065			
			3/8" square drive with centering pin	G2C152	0608800073			
6–35	295	25/39	1/4" quick-change chuck	G1B102	0608800063	3DMC060 0608820113	3GE27 0608720053	3GE67 0608720039
		50/38	1/4" quick-change chuck	G2B152	0608800065			
6–56	295	25/39	3/8" square drive	G1A102	0608800062	3DMC060 0608820113	3GE27 0608720053	3GE67 0608720039
			3/8" square drive with centering pin	G1C102	0608800072			
		50/38	3/8" square drive	G2A152	0608800064			
			3/8" square drive with centering pin	G2C152	0608800073			

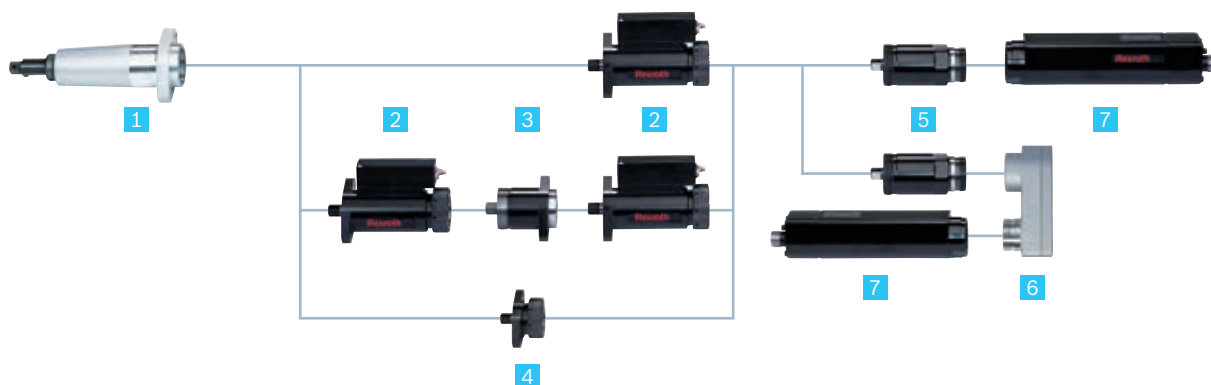

* The accuracy within the working range according to VDI/VDE 2647 is $\pm 2\%$ over 6 s.





Note: You can find component dimensions and 3D/CAD data on the Internet at www.boschrexroth.com/tightening

Spindle bearing size 3 – components



1 Spindle bearing	Code	G1B102	G2B152	G1A102	G1C102	G2A152	G2C152
	Order no.	0608800063	0608800065	0608800062	0608800072	0608800064	0608800073
	Max. torque	Nm 35	35	55	55	55	55
	Range of spring	mm 25	50	25	25	50	50
	Spring force	N 16–39	14–38	16–39	16–39	14–38	14–38
	Reduction	1	1	1	1	1	1
	Avg. efficiency	1	1	1	1	1	1
	Length A	mm 102	152	102	102	152	152
	Installation length	mm 112	162	112	112	162	162
	Weight	kg 0.33	0.41	0.33	0.33	0.41	0.41
2 Measurement transducer	Code	3DMC017	3DMC060				
	Order no.	0608820112	0608820113	You can configure your tightening spindle with a redundant measurement transducer from the same type. Connect both measurement transducers with the redundant adapter. For measurement transducer cables, see page 140.			
	Nominal torque	Nm 17	60				
	Reduction	1	1				
	Avg. efficiency	1	1				
	Installation length	mm 118.6	118.6				
	Weight	kg 1	1				
3 Redundant adapter	Code	3AR					
	Order no.	0608810021		When configuring with a redundant measurement transducer, the adapter connects both measurement transducers.			
	Reduction	1					
	Avg. efficiency	1					
	Installation length	mm 57					
	Weight	kg 0.4					
4 Adapter	Code	3A					
	Order no.	0608810025		When configuring without a measurement transducer, the adapter connects the output drive and the planetary gearbox.			
	Reduction	1					
	Avg. efficiency	1					
	Installation length	mm 30.5					
	Weight	kg 0.3					

5 Planetary gearbox 	Code	3GE27	3GE67	
	Order no.	0608720053	0608720039	
	Reduction	27	67.4	
	Avg. efficiency	0.93	0.9	
	Installation length	mm	65.5	81.5
	Weight	kg	0.35	0.5
6 Transverse gearbox 	Code	3ULG		
	Order no.	0608810037	The transverse gearbox shortens the length of your tightening spindle by the installation length of the EC motor plus the installation length of the transverse gearbox.	
	Reduction	1		
	Avg. efficiency	0.95		
	Installation length	mm		30.1
	Weight	kg		0.4
7 EC motor 	Code	EC303		
	Order no.	0608701017		
	Installation length	mm	219	
	Weight	kg	1.3	

Side-by-side arrangement of tightening spindles (center-to-center distance)						
Number of tightening spindles		2	3	4	5	6
						
Min. circle diameter- $\varnothing d_{min}$ mm	G...	45	52	65	80	89

Tightening spindles size 3

Offset output drive



- ▶ Working range 1.7 – 53 Nm
- ▶ Max. output drive speed 740 rpm

Depending on the size, the actual components may differ from those in the illustration.

FEATURES

- ▶ For tight hole templates
- ▶ Standard tool mounts
- ▶ Maintenance-free for 1 million full-load cycles





Tightening spindle		Offset output drive				Measure- ment transducer	Planetary gearbox	EC motor
Working range	Max. output drive speed	Range of spring mm	Tool mount	Code	Order no.	Code/ Order no.	Code/ Order no.	Code/ Order no.
Nm	rpm							
1.7*-15	740	50	1/4" quick-change chuck	VNS2B152	0608800630	3DMC017 0608820112	3GE27 0608720053	EC303 0608701017
	295	50	1/4" quick-change chuck	VNS2B152	0608800630		3GE67 0608720039	
6*-31	740	50	1/4" quick-change chuck	VNS2B152	0608800630	3DMC060 0608820113	3GE27 0608720053	
6*-33	295	50	1/4" quick-change chuck	VNS2B152	0608800630		3GE67 0608720039	
1.7*-15	740	50	3/8" square drive	VNS2A152	0608800629	3DMC017 0608820112	3GE27 0608720053	
			3/8" square drive with centering pin	VNS2C152	0608800631			
	295	50	3/8" square drive	VNS2A152	0608800629		3GE67 0608720039	
			3/8" square drive with centering pin	VNS2C152	0608800631			
6*-31	740	50	3/8" square drive	VNS2A152	0608800629	3DMC060 0608820113	3GE27 0608720053	
			3/8" square drive with centering pin	VNS2C152	0608800631			
6*-53	295	50	3/8" square drive	VNS2A152	0608800629		3GE67 0608720039	
			3/8" square drive with centering pin	VNS2C152	0608800631			

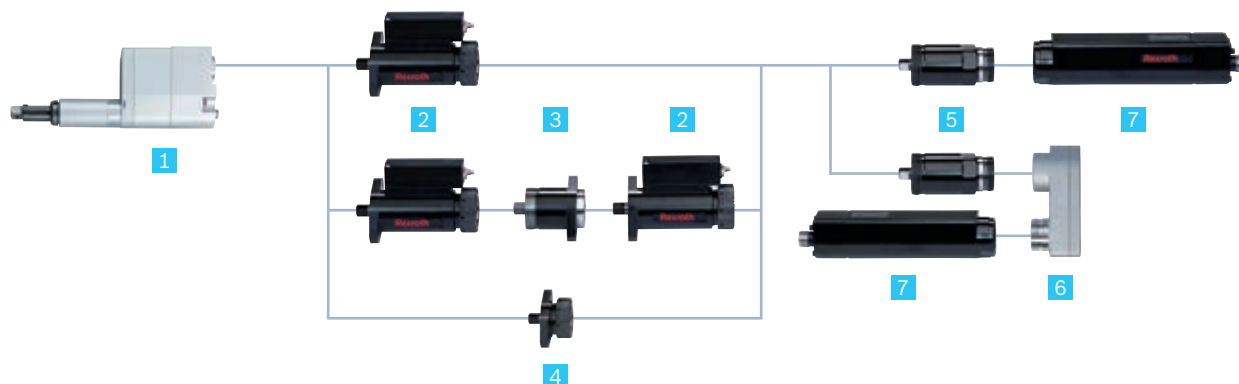

* Depending on the tolerance limits, position-based MCT required

Note: You can find component dimensions and 3D/CAD data on the Internet at www.boschrexroth.com/tightening





Offset output drive size 3 – components



1 Offset output drive	Code	VNS2B152	VNS2A152	VNS2C152
	Order no.	0 608 800 630	0 608 800 629	0 608 800 631
	Max. torque	Nm 35	55	55
	Range of spring	mm 50	50	50
	Spring force	N 14–38	14–38	14–38
	Reduction	1	1	1
	Avg. efficiency	0.93	0.93	0.93
	Length A	mm 152	152	152
	Installation length	mm 240	240	240
	Weight	kg 1.2	1.2	1.2
2 Measurement transducer	Code	3DMC017	3DMC060	
	Order no.	0 608 820 112	0 608 820 113	You can configure your tightening spindle with a redundant measurement transducer from the same type. Connect both measurement transducers with the redundant adapter. For measurement transducer cables, see page 140.
	Nominal torque	Nm 17	60	
	Reduction	1	1	
	Avg. efficiency	1	1	
	Installation length	mm 118.6	118.6	
	Weight	kg 1	1	
3 Redundant adapter	Code	3AR		
	Order no.	0 608 810 021		When configuring with a redundant measurement transducer, the adapter connects both measurement transducers.
	Reduction	1		
	Avg. efficiency	1		
	Installation length	mm 57		
	Weight	kg 0.4		
4 Adapter	Code	3A		
	Order no.	0 608 810 025		When configuring without a measurement transducer, the adapter connects the output drive and the planetary gearbox.
	Reduction	1		
	Avg. efficiency	1		
	Installation length	mm 30.5		
	Weight	kg 0.3		

5 Planetary gearbox 	Code	3GE27	3GE67	
	Order no.	0608720053	0608720039	
	Reduction	27	67.4	
	Avg. efficiency	0.93	0.9	
	Installation length	mm	65.5	81.5
	Weight	kg	0.35	0.5
6 Transverse gearbox 	Code	3ULG		
	Order no.	0608810037	The transverse gearbox shortens the length of your tightening spindle by the installation length of the EC motor plus the installation length of the transverse gearbox.	
	Reduction	1		
	Avg. efficiency	0.95		
	Installation length	mm		30.1
	Weight	kg		0.4
7 EC motor 	Code	EC303		
	Order no.	0608701017		
	Installation length	mm	219	
	Weight	kg	1.3	

Side-by-side arrangement of tightening spindles (center-to-center distance)

Number of tightening spindles		2	3	4	5	6
						
Min. circle diameter- $\varnothing d_{\min}$ mm	VNS2...152	29	33.5	41	49.5	58

Tightening spindles size 3

Offset output drive with integrated measurement transducer



- ▶ Working range 3.2 – 57 Nm
- ▶ Max. output drive speed 740 rpm

Depending on the size, the actual components may differ from those in the illustration.

FEATURES

- ▶ Reduced center-to-center distances
- ▶ Torque measurement directly at the bolt
- ▶ Proximity switching digital measurement transfer
- ▶ Efficiency fluctuations do not affect measurements



Tightening spindle		Offset output drive with integrated measurement transducer				Planetary gearbox	EC motor
Working range Nm	Max. output drive speed 1/min	Range of spring mm	Tool mount	Code	Order no.	Code/ Order no.	Code/ Order no.
3.2*-16	740	50	3/8" square drive	3VMC017	0 608 801 009	3GE27 0608720053	EC303 0608701017
	295	50	3/8" square drive	3VMC017	0 608 801 009	3GE67 0608720039	
6*-31	740	50	3/8" square drive	3VMC035	0 608 801 010	3GE27 0608720053	
6*-33	295	50	3/8" square drive	3VMC035	0 608 801 010	3GE67	
10*-57	295	50	3/8" square drive	3VMC060	0 608 801 011	0608720039	

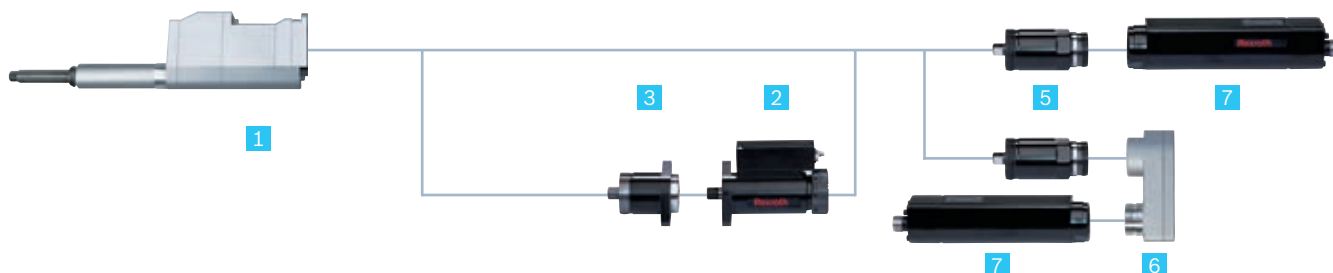

* Depending on the tolerance limits, position-based MCT required

Note: You can find component dimensions and 3D/CAD data on the Internet at www.boschrexroth.com/tightening





Offset output drive with integrated measurement transducer size 3 – components



1 Offset output drive with integrated measurement transducer 	Code		3VMC017	3VMC035	3VMC060
	Order no.		0 608 801 009	0 608 801 010	0 608 801 011
	Max. torque	Nm	17	35	60
	Range of spring	mm	50	50	50
	Spring force	N	14–38	14–38	14–38
	Reduction		1	1	1
	Avg. efficiency		0.93	0.93	0.93
	Length A	mm	152	152	152
	Installation length	mm	311	311	311
	Weight	kg	3.4	3.4	3.4
2 Measurement transducer 	Code		3DMC017	3DMC060	
	Order no.		0 608 820 112	0 608 820 113	You can configure your tightening spindle with a redundant measurement transducer from the same type. Connect both measurement transducers with the redundant adapter. For measurement transducer cables, see page 140.
	Nominal torque	Nm	17	60	
	Reduction		1	1	
	Avg. efficiency		1	1	
	Installation length	mm	118.6	118.6	
Weight	kg	1	1		
3 Redundant adapter 	Code		3AR		
	Order no.		0 608 810 021		When configuring with a redundant measurement transducer, the adapter connects both measurement transducers.
	Reduction		1		
	Avg. efficiency		1		
	Installation length	mm	57		
Weight	kg	0.4			

5 Planetary gearbox 	Code	3GE27	3GE67	
	Order no.	0608720053	0608720039	
	Reduction	27	67.4	
	Avg. efficiency	0.93	0.9	
	Installation length	mm	65.5	81.5
	Weight	kg	0.35	0.5
6 Transverse gearbox 	Code	3ULG		
	Order no.	0608810037		
	Reduction	1		
	Avg. efficiency	0.95		
	Installation length	mm	30.1	The transverse gearbox shortens the length of your tightening spindle by the installation length of the EC motor plus the installation length of the transverse gearbox.
	Weight	kg	0.4	
7 EC motor 	Code	EC303		
	Order no.	0608701017		
	Installation length	mm	219	
	Weight	kg	1.3	

Side-by-side arrangement of tightening spindles (center-to-center distance)

Number of tightening spindles	2	3	4	5	6
					
Min. circle diameter- $\varnothing d_{min}$ mm	3VMC... 31	36	44	53	62

Tightening spindles size 3 Angle head



- ▶ Working range 5.4 – 90 Nm
- ▶ Max. output drive speed 705 rpm

Depending on the size, the actual components may differ from those in the illustration.

FEATURES

- ▶ For restricted accessibility
- ▶ Precision tothing for high torque accuracy
- ▶ Incremental positioning (9° increments)
- ▶ Integrated fastening flanges
- ▶ With integrated measurement transducer on request

Tightening spindle		Angle head			Measurement transducer	Planetary gearbox	EC motor
Working range Nm	Max. output drive speed rpm	Tool mount	Code	Order no.	Code / Order no.	Code / Order no.	Code / Order no.
5.4–16	705	3/8" square drive	3W027	0608810042	3DMC017 0608820112	3GE27 0608720053	EC303 0608701017
	280	3/8" square drive	3W027	0608810042		3GE67 0608720039	
5.7–27	705	3/8" square drive	3W027	0608810042	3DMC060 0608820113	3GE27 0608720053	
	280	3/8" square drive	3W027	0608810042		3GE67 0608720039	
10–33	705	3/8" square drive	3W050	0608810043		3GE27 0608720053	
10–50	280	3/8" square drive	3W050	0608810043		3GE67 0608720039	
18–53	440	1/2" square drive	3W090	0608810044		3GE27 0608720053	
18–90	175	1/2" square drive	3W090	0608810044		3GE67 0608720039	

Note: To ensure troublefree operation, the angle head must always be operated with an output drive axial compensator, e.g. spindle bearing. See page 21.

For an output drive axial compensator, the following angle head/spindle bearing combinations are possible:

3W027 (0608810042) – spindle bearing size 3 (page 30)





3W050 (0608810043) – spindle bearing size 3 (page 30)

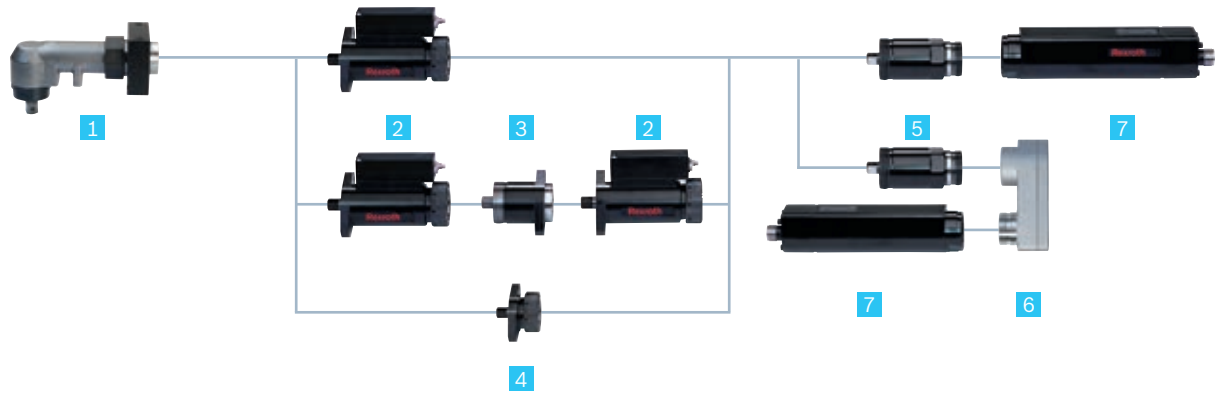

3W090 (0608810044) – spindle bearing size 4 (page 50)





Note: You can find component dimensions and 3D/CAD data on the Internet at www.boschrexroth.com/tightening

Angle head size 3 – components



1 Angle head	Code	3W027	3W050	3W090
	Order no.	0 608 810 042	0 608 810 043	0 608 810 044
	Max. torque	Nm 27	50	90
	Reduction	1.05	1.05	1.67
	Avg. efficiency	0.95	0.95	0.95
	Installation length	mm 85.6	125.6	125.6
	Weight	kg 1	1.42	1.7
2 Measurement transducer	Code	3DMC017	3DMC060	
	Order no.	0 608 820 112	0 608 820 113	You can configure your tightening spindle with a redundant measurement transducer from the same type. Connect both measurement transducers with the redundant adapter. For measurement transducer cables, see page 140.
	Nominal torque	Nm 17	60	
	Reduction	1	1	
	Avg. efficiency	1	1	
	Installation length	mm 118.6	118.6	
	Weight	kg 1	1	
3 Redundant adapter	Code	3AR		
	Order no.	0 608 810 021		When configuring with a redundant measurement transducer, the adapter connects both measurement transducers.
	Reduction	1		
	Avg. efficiency	1		
	Installation length	mm 57		
	Weight	kg 0.4		
4 Adapter	Code	3A		
	Order no.	0 608 810 025		When configuring without a measurement transducer, the adapter connects the output drive and the planetary gearbox.
	Reduction	1		
	Avg. efficiency	1		
	Installation length	mm 30.5		
	Weight	kg 0.3		

5 Planetary gearbox 	Code	3GE27	3GE67	
	Order no.	0608720053	0608720039	
	Reduction	27	67.4	
	Avg. efficiency	0.93	0.9	
	Installation length	mm	65.5	81.5
	Weight	kg	0.35	0.5
6 Transverse gearbox 	Code	3ULG		
	Order no.	0608810037		
	Reduction	1		
	Avg. efficiency	0.95		
	Installation length	mm	30.1	The transverse gearbox shortens the length of your tightening spindle by the installation length of the EC motor plus the installation length of the transverse gearbox.
	Weight	kg	0.4	
7 EC motor 	Code	EC303		
	Order no.	0608701017		
	Installation length	mm	219	
	Weight	kg	1.3	

Side-by-side arrangement of tightening spindles (center-to-center distance)						
Number of tightening spindles		2	3	4	5	6
						
Min. circle diameter- \varnothing d_{min} mm	3W027	29	34	41	50	58
	3W050	35	40	50	60	70
	3W090	45	52	64	78	90

Tightening spindles size 3

Feed output drive



- ▶ Working range 1.7 – 53 Nm
- ▶ Max. output drive speed 740 rpm

Depending on the size, the actual components may differ from those in the illustration.

FEATURES

- ▶ Integrated feed movement
- ▶ In connection with automatic bolt supply
- ▶ Standard tool mounts and compressed air connections
- ▶ Maintenance-free for 1 million full-load cycles





Tightening spindle		Feed output drive				Measurement transducer	Planetary gearbox	EC motor
Working range Nm	Max. output drive speed rpm	Stroke mm	Tool mount	Code	Order no.	Code/ Order no.	Code/ Order no.	Code/ Order no.
1.7*-15	740	200	3/8" square drive	3S1M8	0 608 800 648	3DMC017 0608820112	3GE27 0608720053	EC303 0608701017
	295	200	3/8" square drive	3S1M8	0 608 800 648		3GE67 0608720039	
1.7*-15	740	200	1/4" square drive	3S2M8	0 608 800 649		3GE27 0608720053	
	295	200	1/4" square drive	3S2M8	0 608 800 649		3GE67 0608720039	
5.3*-20	295	200	1/4" square drive	3S2M8	0 608 800 649	3DMC060 0608820113	3GE67 0608720039	
	740	200	1/4" square drive	3S2M8	0 608 800 649		3GE27 0608720053	
7*-31	740	200	3/8" square drive	3S1M8	0 608 800 648		3GE27 0608720053	
6*-53	295	200	3/8" square drive	3S1M8	0 608 800 648		3GE67 0608720039	

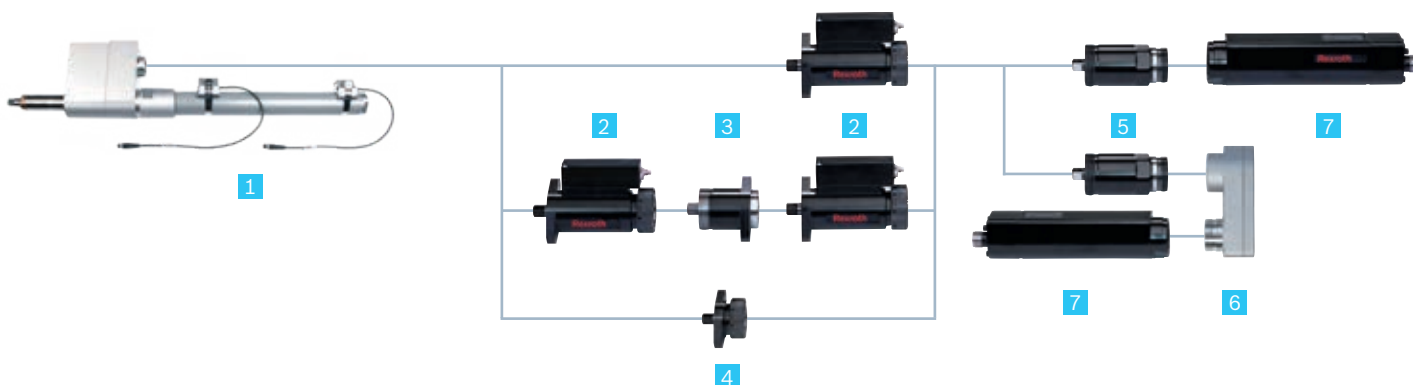

* Depending on the tolerance limits, position-based MCT required

Note: You can find component dimensions and 3D/CAD data on the Internet at www.boschrexroth.com/tightening





Feed output drive size 3 – components



1 Feed output drive	Code	3S2M8	3S1M8	
	Order no.	0 608 800 649	0 608 800 648	
	Max. torque	Nm 20	55	
	Stroke	mm 200	200	
	Max. air pressure	bar 4	4	
	Reduction	1	1	
	Avg. efficiency	0.93	0.93	
	Length A	mm 97	97	
	Installation length	mm 204	204	
	Weight	kg 3.5	3.5	
2 Measurement transducer	Code	3DMC017	3DMC060	
	Order no.	0 608 820 112	0 608 820 113	You can configure your tightening spindle with a redundant measurement transducer from the same type. Connect both measurement transducers with the redundant adapter. For measurement transducer cables, see page 140.
	Nominal torque	Nm 17	60	
	Reduction	1	1	
	Avg. efficiency	1	1	
	Installation length	mm 118.6	118.6	
	Weight	kg 1	1	
3 Redundant adapter	Code	3AR		
	Order no.	0 608 810 021		When configuring with a redundant measurement transducer, the adapter connects both measurement transducers.
	Reduction	1		
	Avg. efficiency	1		
	Installation length	mm 57		
	Weight	kg 0.4		
4 Adapter	Code	3A		
	Order no.	0 608 810 025		When configuring without a measurement transducer, the adapter connects the output drive and the planetary gearbox.
	Reduction	1		
	Avg. efficiency	1		
	Installation length	mm 30.5		
	Weight	kg 0.3		

5 Planetary gearbox 	Code	3GE27	3GE67	
	Order no.	0608720053	0608720039	
	Reduction	27	67.4	
	Avg. efficiency	0.93	0.9	
	Installation length	mm	65.5	81.5
	Weight	kg	0.35	0.5
6 Transverse gearbox 	Code	3ULG		
	Order no.	0608810037		The transverse gearbox shortens the length of your tightening spindle by the installation length of the EC motor plus the installation length of the transverse gearbox.
	Reduction	1		
	Avg. efficiency	0.95		
	Installation length	mm	30.1	
Weight	kg	0.4		
7 EC motor 	Code	EC303		
	Order no.	0608701017		
	Installation length	mm	219	
	Weight	kg	1.3	

Side-by-side arrangement of tightening spindles (center-to-center distance)

Number of tightening spindles		2	3	4	5	6
						
Min. circle diameter- $\varnothing d_{\min}$ mm	3S...	49	56.5	69.5	83.5	98

Tightening spindles size 4

Spindle bearing



- ▶ Working range 5.7 – 150 Nm
- ▶ Max. output drive speed 1,000 rpm

Depending on the size, the actual components may differ from those in the illustration.

FEATURES

- ▶ Various lengths with axial compensator
- ▶ Standard tool mounts
- ▶ Maximum efficiency
- ▶ Maintenance-free for 1 million full-load cycles

Tightening spindle		Spindle bearing				Measurement transducer	Planetary gearbox	EC motor					
Working range*	Max. output drive speed	Range of spring mm / Max. Spring force N	Tool mount	Code	Order no.	Code / Order no.	Code / Order no.	Code / Order no.					
Nm	rpm												
5.7–56	340	25 / 93.3	1/2" square drive	GK1A156	0 608 800 031	4DMC060 0 608 820 114	4GE59 0 608 720 040	EC304 0 608 701 018					
			7/16" quick-change chuck	GK1B156	0 608 800 020								
			1/2" square drive with centering pin	GK1C156	0 608 800 001								
		50 / 93.3	1/2" square drive	GK2A181/251	0 608 800 006 / 048								
			7/16" quick-change chuck	GK2B181/251	0 608 800 008 / 049								
			1/2" square drive with centering pin	GK2C181/251	0 608 800 021 / 050								
			1/2" square drive	GL2A319	0 608 800 056								
			7/16" quick-change chuck	GL2B319	0 608 800 057								
			1/2" square drive with centering pin	GL2C319	0 608 800 027								
		5.7–54	1,000	25 / 90.2	1/2" square drive				GK1A156	0 608 800 031	4DMC060 0 608 820 114	4GE19 0 608 720 056	
					7/16" quick-change chuck				GK1B156	0 608 800 020			
					1/2" square drive with centering pin				GK1C156	0 608 800 001			
50 / 93.3	1/2" square drive			GK2A181/251	0 608 800 006 / 048								
	7/16" quick-change chuck			GK2B181/251	0 608 800 008 / 049								
	1/2" square drive with centering pin			GK2C181/251	0 608 800 021 / 050								
	1/2" square drive			GL2A319	0 608 800 056								
	7/16" quick-change chuck			GL2B319	0 608 800 057								
	1/2" square drive with centering pin			GL2C319	0 608 800 027								
15–150	340			25 / 93.3	1/2" square drive	GK1A156	0 608 800 031	4DMC160 0 608 820 115	4GE59 0 608 720 040				
					7/16" quick-change chuck	GK1B156	0 608 800 020						
					1/2" square drive with centering pin	GK1C156	0 608 800 001						
		50 / 93.3	1/2" square drive	GK2A181/251	0 608 800 006 / 048								
			7/16" quick-change chuck	GK2B181/251	0 608 800 008 / 049								
			1/2" square drive with centering pin	GK2C181/251	0 608 800 021 / 050								
			1/2" square drive	GL2A319	0 608 800 056								
			7/16" quick-change chuck	GL2B319	0 608 800 057								
			1/2" square drive with centering pin	GL2C319	0 608 800 027								



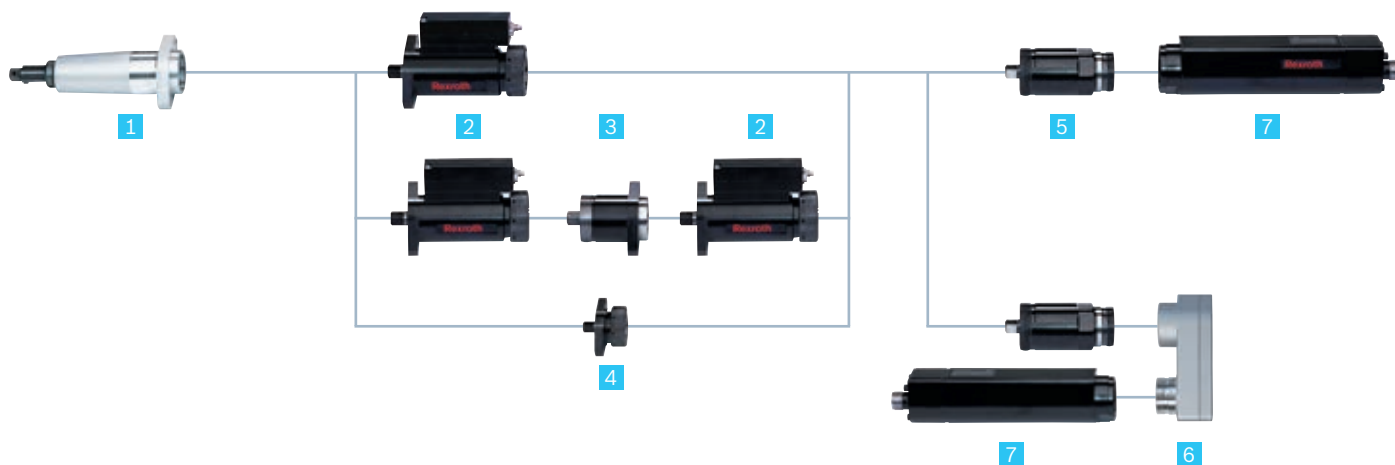

* The accuracy within the working range according to VDI/VDE 2647 is $\pm 2\%$ (6 s).

Note: You can find component dimensions and 3D/CAD data on the Internet at www.boschrexroth.com/tightening





Spindle bearing size 4 – components



1 Spindle bearing	Code	GK1A156	GK1B156	GK1C156	GK2A181	GK2B181	GK2C181
	Order no.	0608800031	0608800020	0608800001	0608800006	0608800008	0608800021
	Max. torque	Nm 150	150	150	150	150	150
	Range of spring	mm 25	25	25	50	50	50
	Spring force	N 39–90	39–90	39–90	30–93	30–93	30–93
	Reduction	1	1	1	1	1	1
	Avg. efficiency	1	1	1	1	1	1
	Length A	mm 156	156	156	181	181	181
	Installation length	mm 170	170	170	195	195	195
	Weight	kg 0.9	0.9	0.9	1	1	1
1 Spindle bearing	Code	GK2A251	GK2B251	GK2C251	GL2A319	GL2B319	GL2C319
	Order no.	0608800048	0608800049	0608800050	0608800056	0608800057	0608800027
	Max. torque	Nm 150	150	150	150	150	150
	Range of spring	mm 50	50	50	50	50	50
	Spring force	N 30–93	30–93	30–93	30–93	30–93	30–93
	Reduction	1	1	1	1	1	1
	Avg. efficiency	1	1	1	1	1	1
	Length A	mm 251	251	251	319	319	319
	Installation length	mm 265	265	265	333	333	333
	Weight	kg 1	1	1	2.1	2.1	2.1
2 Measurement transducer	Code	4DMC060	4DMC160				
	Order no.	0608820114	0608820115	You can configure your tightening spindle with a redundant measurement transducer from the same type. Connect both measurement transducers with the redundant adapter. For measurement transducer cables, see page 140.			
	Max. torque	Nm 60	160				
	Reduction	1	1				
	Avg. efficiency	1	1				
	Length	mm 182	182				
	Installation length A	mm 122	122				
	Weight	kg 1.6	1.6				
3 Redundant adapter	Code	4AR					
	Order no.	0608810022	When configuring with a redundant measurement transducer, the adapter connects both measurement transducers.				
	Reduction	1					
	Avg. efficiency	1					
	Installation length	mm 65					
	Weight	kg 0.8					

4 Adapter 	Code	4A		When configuring without a measurement transducer, the adapter connects the output drive and the planetary gearbox.
	Order no.	0 608 810 026		
	Reduction	1		
	Avg. efficiency	1		
	Installation length	mm	26.5	
Weight	kg	0.4		
5 Planetary gearbox 	Code	4GE19	4GE59	
	Order no.	0 608 720 056	0 608 720 040	
	Reduction	19.3	58.6	
	Avg. efficiency	0.93	0.9	
	Installation length	mm	82.9	105.5
Weight	kg	0.7	1.1	
6 Transverse gearbox 	Code	4ULG		The transverse gearbox shortens the length of your tightening spindle by the installation length of the EC motor plus the installation length of the transverse gearbox.
	Order no.	0 608 810 038		
	Reduction	1		
	Avg. efficiency	0.95		
	Installation length	mm	41.3	
Weight	kg	1.3		
7 EC motor 	Code	EC304		
	Order no.	0 608 701 018		
	Installation length	mm	247	
	Weight	kg	2.7	

Side-by-side arrangement of tightening spindles (center-to-center distance)

Number of tightening spindles	2	3	4	5	6
					
Min. circle diameter- $\varnothing d_{min}$ mm	G... 59	69	89	109	119

Tightening spindles size 4

Offset output drive



- ▶ Working range 6 – 340 Nm
- ▶ Max. output drive speed 1,000 rpm

Depending on the size, the actual components may differ from those in the illustration.

FEATURES

- ▶ For tight hole templates, side-by-side arrangement with small center-to-center distances
- ▶ Standard tool mounts
- ▶ Maintenance-free for 1 million full-load cycles





Tightening spindle		Offset output drive				Measurement transducer	Planetary gearbox	EC motor
Working range	Max. output drive speed rpm	Range of spring	Tool mount	Code	Order no.	Code/Order no.	Code/Order no.	Code/Order no.
Nm		mm						
6*-49	1,000	50	1/2" square drive	VNK2A181/251	0 608 800 632 / 633	4DMC060 0 608 820 114	4GE19 0 608 720 056	EC304 0 608 701 018
			7/16" change chuck	VNK2B181/251	0 608 800 634 / 635			
			1/2" square drive with centering pin	VNK2C181/251	0 608 800 636 / 637			
			1/2" square drive	VNL2A319	0 608 800 639			
			1/2" square drive with centering pin	VNL2C319	0 608 800 643			
8*-73	740	50	3/4" square drive	VUK2D242	0 608 PE0 588			
13*-128	410	50	3/4" square drive	VUK2D186	0 608 800 644			
				VUL2D290	0 608 800 645			
15*-138	340	50	1/2" square drive	VNK2A181/251	0 608 800 632 / 633	4DMC160 0 608 820 115	4GE59 0 608 720 040	
			7/16" quick-change chuck	VNK2B181/251	0 608 800 634 / 635			
			1/2" square drive with centering pin	VNK2C181/251	0 608 800 636 / 637			
			1/2" square drive	VNL2A319	0 608 800 639			
			1/2" square drive with centering pin	VNL2C319	0 608 800 643			
20*-200	240	50	3/4" square drive	VUK2D242	0 608 PE0 588			
35*-340	135	50	3/4" square drive	VUK2D186	0 608 800 644			
				VUL2D290	0 608 800 645			

* Depending on the tolerance limits, position-based MCT required

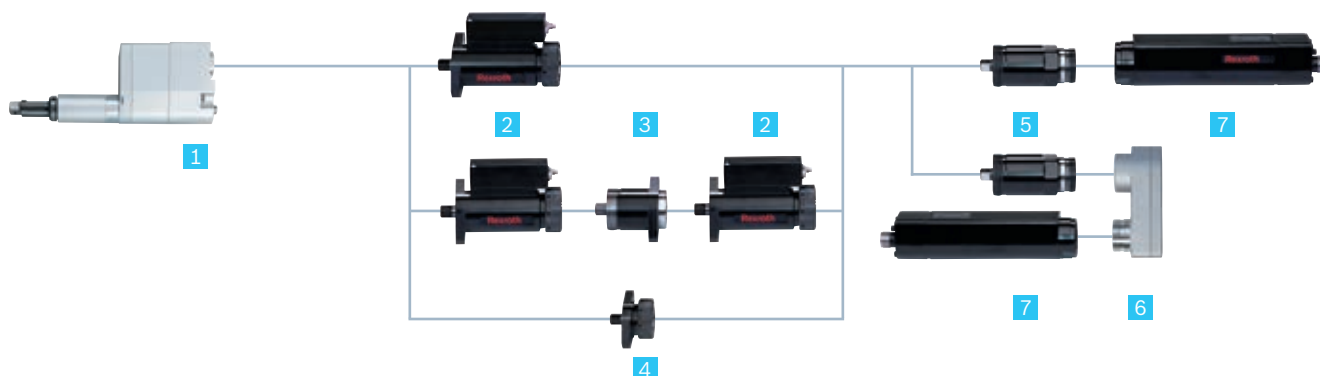
Note: You can find component dimensions and 3D/CAD data on the Internet at www.boschrexroth.com/tightening





Offset output drive size 4 – components







1 Offset output drive 	Code		VNK2A181	VNK2B181	VNK2C181	VNK2A251	VNK2B251	VNK2C251
	Order no.		0608800632	0608800634	0608800636	0608800633	0608800635	0608800637
	Max. torque	Nm	150	150	150	150	150	150
	Range of spring	mm	50	50	50	50	50	50
	Spring force	N	30–93	30–93	30–93	30–93	30–93	30–93
	Reduction		1	1	1	1	1	1
	Avg. efficiency		0.91	0.91	0.91	0.91	0.91	0.91
	Length A	mm	182	182	182	252	252	252
	Installation length	mm	309	309	309	379	379	379
Weight	kg	3.4	3.4	3.4	4.0	4.0	4.0	
1 Offset output drive 	Code		VNL2A319	VNL2C319	VUK2D242	VUK2D186	VUL2D290	
	Order no.		0608800639	0608800643	0608PE0588	0608800644	0608800645	
	Max. torque	Nm	150	150	200	340	340	
	Range of spring	mm	50	50	50	50	50	
	Spring force	N	30–93	30–93	30–93	30–93	30–93	
	Reduction		1	1	1.46	2.56	2.56	
	Avg. efficiency		0.91	0.91	0.92	0.92	0.92	
	Length A	mm	182	182	242	252	252	
	Installation length	mm	448	448	370	354	458	
Weight	kg	4.5	4.5	5.8	7.7	8.5		
2 Measurement transducer 	Code		4DMC060	4DMC160				
	Order no.		0608820114	0608820115				
	Max. torque	Nm	60	160				
	Reduction		1	1				
	Avg. efficiency		1	1				
	Length	mm	182	182				
	Installation length A	mm	122	122				
Weight	kg	1.6	1.6					
3 Redundant adapter 	Code		4AR					
	Order no.		0608810022					
	Reduction		1					
	Avg. efficiency		1					
	Installation length	mm	65					
Weight	kg	0.8						

You can configure your tightening spindle with a redundant measurement transducer from the same type. Connect both measurement transducers with the redundant adapter. For measurement transducer cables, see page 140.

When configuring with a redundant measurement transducer, the adapter connects both measurement transducers.

4 Adapter 	Code	4A		When configuring without a measurement transducer, the adapter connects the output drive and the planetary gearbox.
	Order no.	0 608 810 026		
	Reduction	1		
	Avg. efficiency	1		
	Installation length	mm	26.5	
Weight	kg	0.4		
5 Planetary gearbox 	Code	4GE19	4GE59	
	Order no.	0 608 720 056	0 608 720 040	
	Reduction	19.3	58.6	
	Avg. efficiency	0.93	0.9	
	Installation length	mm	82.9	105.5
Weight	kg	0.7	1.1	
6 Transverse gearbox 	Code	4ULG		The transverse gearbox shortens the length of your tightening spindle by the installation length of the EC motor plus the installation length of the transverse gearbox.
	Order no.	0 608 810 038		
	Reduction	1		
	Avg. efficiency	0.95		
	Installation length	mm	41.3	
Weight	kg	1.3		
7 EC motor 	Code	EC304		
	Order no.	0 608 701 018		
	Installation length	mm	247	
	Weight	kg	2.7	

Side-by-side arrangement of tightening spindles (center-to-center distance)

Number of tightening spindles		2	3	4	5	6
						
Min. circle diameter- \varnothing d_{min} mm	VN...	44	51	63	75	88
	VU...	57	66	81	97	114
	VUK2D242	48	56	68	82	96

Tightening spindles size 4

Offset output drive with integrated measurement transducer



- ▶ Working range 15 – 342 Nm
- ▶ Max. output drive speed 1,000 rpm

Depending on the size, the actual components may differ from those in the illustration.

FEATURES

- ▶ Reduced center-to-center distances
- ▶ Torque measurement directly at the bolt
- ▶ Proximity switching digital measurement transfer
- ▶ Efficiency fluctuations do not affect measurements





Tightening spindle		Offset output drive with integrated measurement transducer				Planetary gearbox	EC motor
Working range Nm	Max. output drive speed rpm	Range of spring mm	Tool mount	Code	Order no.	Code/ Order no.	Code/ Order no.
15*-49	1,000	80	1/2" square drive	4VMC150	0608801004	4GE19	EC304
21*-73	700	80	3/4" square drive	4VMC210	0608801005	0608720056	0608701018
36*-128	410	80	3/4" square drive	4VMC360	0608801006		
15*-142	340	80	1/2" square drive	4VMC150	0608801004	4GE59	
21*-200	240	80	3/4" square drive	4VMC210	0608801005	0608720040	
36*-342	135	80	3/4" square drive	4VMC360	0608801006		

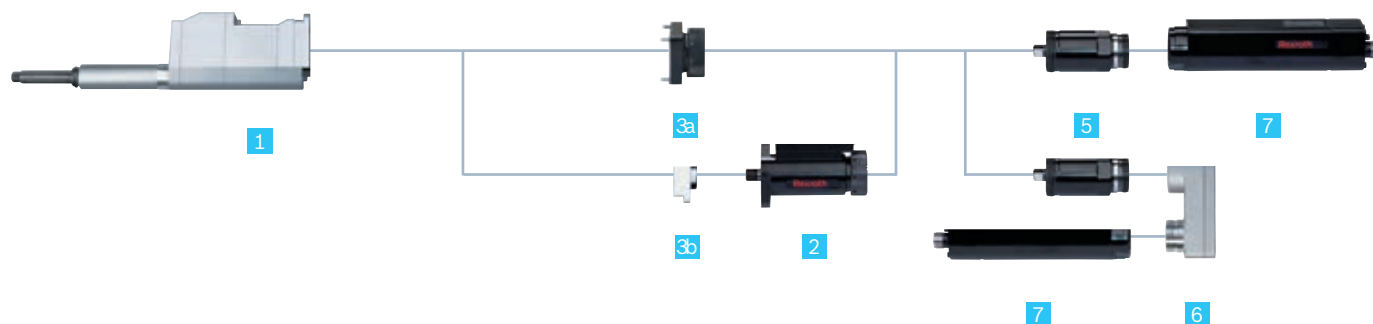

* Depending on the tolerance limits, position-based MCT required

Note: You can find component dimensions and 3D/CAD data on the Internet at www.boschrexroth.com/tightening





Offset output drive with integrated measurement transducer size 4 – components



1 Offset output drive with integrated measurement transducer 	Code	4VMC150	4VMC210	4VMC360	
	Order no.	0 608 801 004	0 608 801 005	0 608 801 006	
	Max. torque	Nm	150	210	360
	Range of spring	mm	80	80	80
	Spring force	N	30–100	30–100	30–100
	Reduction		1	1.46	2.56
	Avg. efficiency		0.92	0.92	0.92
	Length A	mm	242	252	246
	Installation length	mm	438	438	476
Weight	kg	4.9	7.1	11.7	
2 Measurement transducer 	Code	4DMC060	4DMC160		
	Order no.	0 608 820 114	0 608 820 115	You can configure your tightening spindle with a redundant measurement transducer from the same type. Connect both measurement transducers with the redundant adapter. For measurement transducer cables, see page 140.	
	Max. torque	Nm	60	160	
	Reduction		1	1	
	Avg. efficiency		1	1	
	Installation length	mm	122	122	
Weight	kg	1.6	1.6		
3a AVG adapter 	Code	4AVG			
	Order no.	0 608 801 008		The adapter connects the output drive and the planetary gearbox.	
	Reduction		1		
	Avg. efficiency		1		
	Installation length	mm	26.5		
	Weight	kg	0.4		
3b AVR Redundant adapter 	Code	4AVR			
	Order no.	0 608 801 007		When configuring an offset output drive with integrated measurement transducer and redundant measurement transducer, the adapter connects both components.	
	Reduction		1		
	Avg. efficiency		1		
	Installation length	mm	30.3		
	Weight	kg	0.7		

5 Planetary gearbox 	Code	4GE19	4GE59	
	Order no.	0 608 720 056	0 608 720 040	
	Reduction	19.3	58.6	
	Avg. efficiency	0.93	0.9	
	Installation length	mm	82.9	105.5
	Weight	kg	0.7	1.1
6 Transverse gearbox 	Code	4ULG		
	Order no.	0 608 810 038		
	Reduction	1		
	Avg. efficiency	0.95		
	Installation length	mm	41.3	
	Weight	kg	1.3	
The transverse gearbox shortens the length of your tightening spindle by the installation length of the EC motor plus the installation length of the transverse gearbox.				
7 EC motor 	Code	EC304		
	Order no.	0 608 701 018		
	Installation length	mm	247	
	Weight	kg	2.7	

Side-by-side arrangement of tightening spindles (center-to-center distance)

Number of tightening spindles	2	3	4	5	6
					
Min. circle diameter- \varnothing d_{\min} mm	4VMC150 44	4VMC150 51	4VMC150 63	4VMC150 75	4VMC150 88
	4VMC210 48	4VMC210 56	4VMC210 68	4VMC210 82	4VMC210 96
	4VMC360 57	4VMC360 66	4VMC360 81	4VMC360 97	4VMC360 114

Tightening spindles size 4

Angle head



- ▶ Working range 26–220 Nm
- ▶ Max. output drive speed 985 rpm

Depending on the size, the actual components may differ from those in the illustration.

FEATURES

- ▶ For restricted accessibility
- ▶ Precision tothing for high torque accuracy
- ▶ Incremental positioning (10° increments)
- ▶ Integrated fastening flanges
- ▶ With integrated measurement transducer on request

Tightening spindle		Angle head			Measurement transducer	Planetary gearbox	EC motor
Working range Nm	Max. output drive speed rpm	Tool mount	Code	Order no.	Code/ Order no.	Code/ Order no.	Code/ Order no.
26–54	985	1/2" square drive	4W130	0608810045	4DMC060	4GE19	EC304
44–86	620	3/4" square drive	4W220	0608810046	0608820114	0608720056	0608701018
26–130	320	1/2" square drive	4W130	0608810045	4DMC160	4GE59	
44–220	200	3/4" square drive	4W220	0608810046	0608820115	0608720040	

Notes: To ensure troublefree operation, the angle head must always be operated with an output drive axial compensator, e.g. spindle bearing. See page 21.

For an output drive axial compensator, the following angle head/spindle bearing combinations are possible:





4W130 (0608810045) – spindle bearing size 4 (page 50)

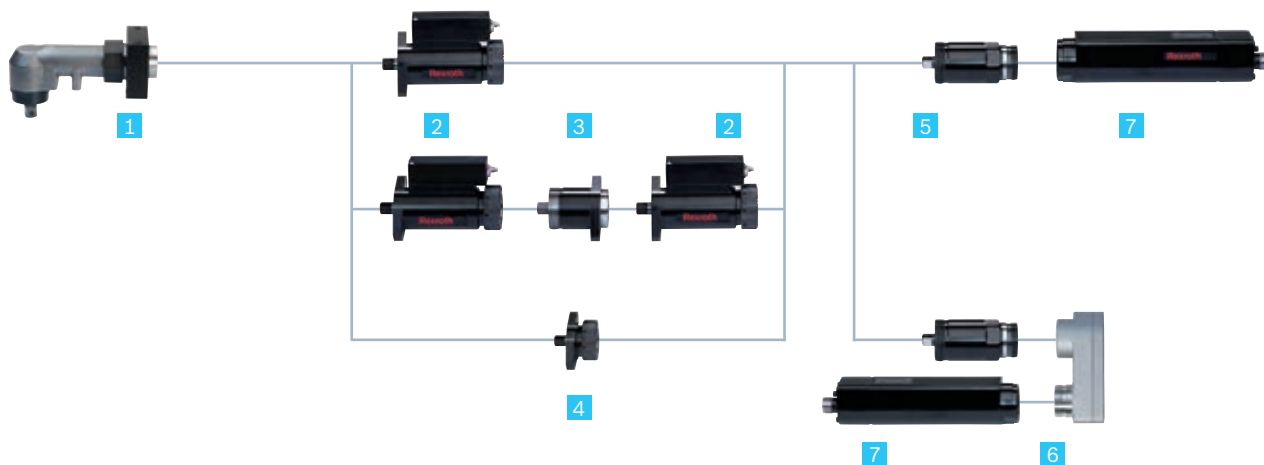

4W220 (0608810046) – on request

You can find component dimensions and 3D/CAD data on the Internet at www.boschrexroth.com/tightening





Angle head size 4 – components



1 Angle head 	Code		4W130	4W220	
	Order no.		0 608 810 045	0 608 810 046	
	Max. torque	Nm	130	220	
	Reduction		1.05	1.67	
	Avg. efficiency		0.95	0.95	
	Installation length	mm	141.5	141.5	
	Weight	kg	2.8	3.2	
2 Measurement transducer 	Code		4DMC060	4DMC160	
	Order no.		0 608 820 114	0 608 820 115	You can configure your tightening spindle with a redundant measurement transducer from the same type. Connect both measurement transducers with the redundant adapter. For measurement transducer cables, see page 140.
	Nominal torque	Nm	60	160	
	Reduction		1	1	
	Avg. efficiency		1	1	
	Installation length	mm	122	122	
	Weight	kg	1.6	1.6	
3 Redundant adapter 	Code		4AR		When configuring with a redundant measurement transducer, the adapter connects both measurement transducers.
	Order no.		0 608 810 022		
	Reduction		1		
	Avg. efficiency		1		
	Installation length	mm	65		
	Weight	kg	0.8		
4 Adapter 	Code		4A		When configuring without a measurement transducer, the adapter connects the output drive and the planetary gearbox.
	Order no.		0 608 810 026		
	Reduction		1		
	Avg. efficiency		1		
	Installation length	mm	26.5		
	Weight	kg	0.4		

5 Planetary gearbox 	Code	4GE19	4GE59
	Order no.	0 608 720 056	0 608 720 040
	Reduction	19.3	58.6
	Avg. efficiency	0.93	0.9
	Installation length	mm 82.9	105.5
	Weight	kg 0.7	1.1
6 Transverse gearbox 	Code	4ULG	
	Order no.	0 608 810 038	The transverse gearbox shortens the length of your tightening spindle by the installation length of the EC motor plus the installation length of the transverse gearbox.
	Reduction	1	
	Avg. efficiency	0.95	
	Installation length	mm 41.3	
	Weight	kg 1.3	
7 EC motor 	Code	EC304	
	Order no.	0 608 701 018	
	Installation length	mm 247	
	Weight	kg 2.7	

Side-by-side arrangement of tightening spindles (center-to-center distance)

Number of tightening spindles	2	3	4	5	6
					
Min. circle diameter- $\varnothing d_{\min}$	4W130	47	55	67	80
mm	4W220	62	72	88	106
					124

Tightening spindles size 4

Feed output drive



- ▶ Working range 6 – 138 Nm
- ▶ Max. output drive speed 1,000 rpm

Depending on the size, the actual components may differ from those in the illustration.

FEATURES

- ▶ Integrated feed movement
- ▶ In connection with automatic bolt supply
- ▶ Standard tool mounts and compressed air connections
- ▶ Maintenance-free for 1 million full-load cycles





Tightening spindle			Feed output drive			Measurement transducer	Planetary gearbox	EC motor
Working range Nm	Max. output drive speed rpm	Stroke mm	Tool mount	Code	Order no.	Code/ Order no.	Code/ Order no.	Code/ Order no.
6*-49	1,000	200	1/2" square drive with centering pin	4S1M8	0 608 800 650	4DMC060 0608820114	4GE19 0608720056	EC304 0608701018
15*-138	340	200	1/2" square drive with centering pin	4S1M8	0 608 800 650	4DMC160 0608820115	4GE59 0608720040	

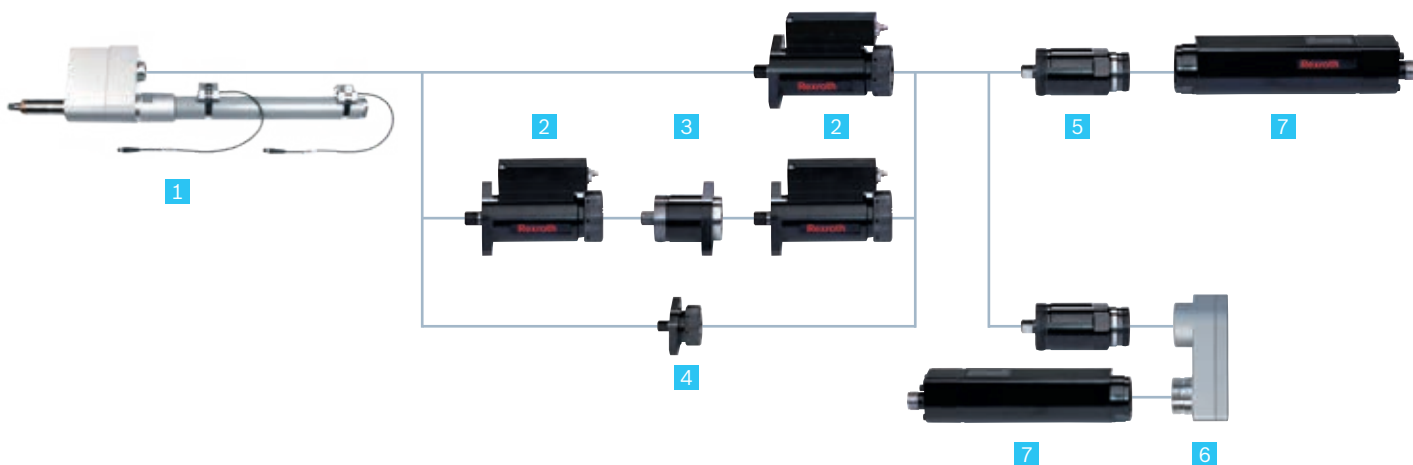

* Depending on the tolerance limits, position-based MCT required

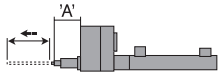
Note: You can find component dimensions and 3D/CAD data on the Internet at www.boschrexroth.com/tightening





Feed output drive size 4 – components



1 Feed output drive 	Code	4S1M8			
	Order no.	0 608 800 650			
	Max. torque	Nm	150		
	Stroke	mm	200		
	Max. air pressure	bar	4		
	Reduction		1		
	Avg. efficiency		0.93		
	Length A	mm	101		
	Installation length	mm	219		
	Weight	kg	6.6		
2 Measurement transducer 	Code	4DMC060	4DMC160		
	Order no.	0 608 820 114	0 608 820 115	You can configure your tightening spindle with a redundant measurement transducer from the same type. Connect both measurement transducers with the redundant adapter. For measurement transducer cables, see page 140.	
	Nominal torque	Nm	60		160
	Reduction		1		1
	Avg. efficiency		1		1
	Installation length	mm	122		122
Weight	kg	1.6	1.6		
3 Redundant adapter 	Code	4AR			
	Order no.	0 608 810 022		When configuring with a redundant measurement transducer, the adapter connects both measurement transducers.	
	Reduction	1			
	Avg. efficiency	1			
	Installation length	mm	65		
Weight	kg	0.8			
4 Adapter 	Code	4A			
	Order no.	0 608 810 026		When configuring without a measurement transducer, the adapter connects the output drive and the planetary gearbox.	
	Reduction	1			
	Avg. efficiency	1			
	Installation length	mm	26.5		
Weight	kg	0.4			

5 Planetary gearbox 	Code	4GE19	4GE59
	Order no.	0 608 720 056	0 608 720 040
	Reduction	19.3	58.6
	Avg. efficiency	0.93	0.9
	Installation length	mm 82.9	105.5
	Weight	kg 0.7	1.1
6 Transverse gearbox 	Code	4ULG	
	Order no.	0 608 810 038	The transverse gearbox shortens the length of your tightening spindle by the installation length of the EC motor plus the installation length of the transverse gearbox.
	Reduction	1	
	Avg. efficiency	0.95	
	Installation length	mm 41.3	
	Weight	kg 1.3	
7 EC motor 	Code	EC304	
	Order no.	0 608 701 018	
	Installation length	mm 247	
	Weight	kg 2.7	

Side-by-side arrangement of tightening spindles (center-to-center distance)

Number of tightening spindles	2	3	4	5	6
					
Min. circle diameter- $\varnothing d_{\min}$ mm	4S1M8 56	65	79	95	112

Tightening spindles size 5

Spindle bearing



- ▶ Working range 50–500 Nm
- ▶ Max. output drive speed 515 rpm

Depending on the size, the actual components may differ from those in the illustration.

FEATURES

- ▶ Various lengths with axial compensator
- ▶ Standard tool mounts
- ▶ Maximum efficiency
- ▶ Maintenance-free for 1 million full-load cycles





Tightening spindle			Spindle bearing			Measurement transducer	Planetary gearbox	EC motor
Working range*	Max. output drive speed	Range of spring mm/ max. spring force N	Tool mount	Code	Order no.	Code/ Order no.	Code/ Order no.	Code/ Order no.
Nm	rpm							
50–160	515	80/155	3/4" square drive with centering pin	GK3C281	0 608 800 079	5DMC530 0 608 820 116	5GE19 0 608 720 058	EC305 0 608 701 019
				GK3C350	0 608 800 081			
				GL3C418	0 608 800 084			
50–500	145	80/155	3/4" square drive with centering pin	GK3C281	0 608 800 079		5GE68 0 608 720 041	
				GK3C350	0 608 800 081			
				GL3C418	0 608 800 084			

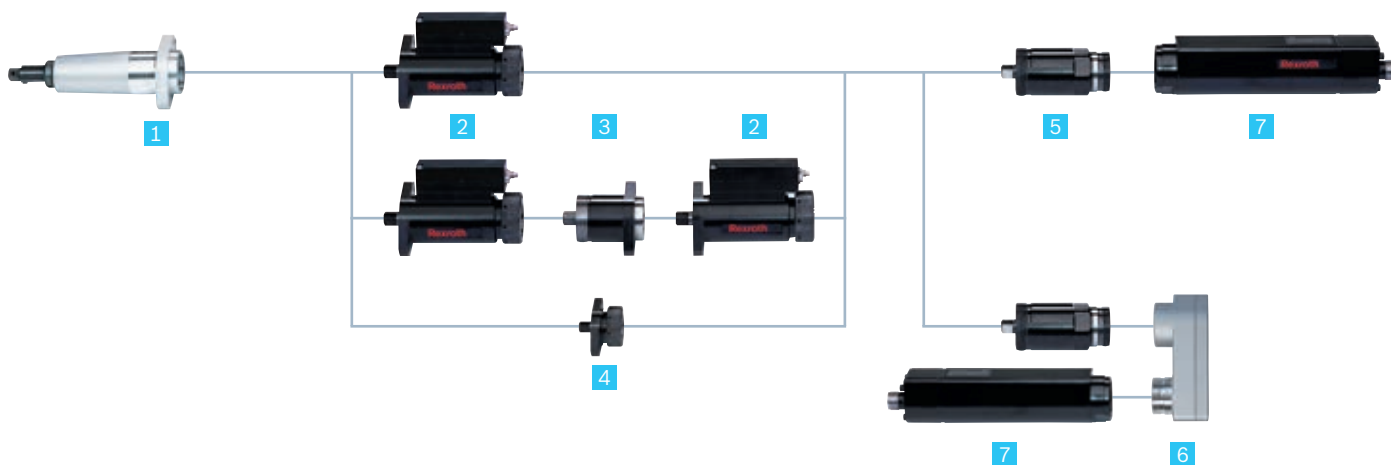

*The accuracy within the working range according to VDI/VDE 2647 is $\pm 2\%$ over 6 s.





Note: You can find component dimensions and 3D/CAD data on the Internet at www.boschrexroth.com/tightening

Spindle bearing size 5 – components



1 Spindle bearing 	Code	GK3C281	GK3C350	GL3C418	
	Order no.	0 608 800 079	0 608 800 081	0 608 800 084	
	Max. torque	Nm	500	500	500
	Range of spring	mm	80	80	80
	Spring force	N	40–155	40–155	40–155
	Reduction		1	1	1
	Avg. efficiency		1	1	1
	Length A	mm	284	353	421
	Installation length	mm	302	371	439
Weight	kg	3	3.5	4.5	
2 Measurement transducer 	Code	5DMC530			
	Order no.	0 608 820 116			
	Nominal torque	Nm	530		
	Reduction		1		
	Avg. efficiency		1		
	Installation length	mm	125.5		
Weight	kg	3.7			
3 Redundant adapter 	Code	5AR			
	Order no.	0 608 810 023			
	Reduction		1		
	Avg. efficiency		1		
	Installation length	mm	108		
	Weight	kg	2.4		
4 Adapter 	Code	5A			
	Order no.	0 608 810 027			
	Reduction		1		
	Avg. efficiency		1		
	Installation length	mm	48.5		
	Weight	kg	2.2		
				You can configure your tightening spindle with a redundant measurement transducer from the same type. Connect both measurement transducers with the redundant adapter. For measurement transducer cables, see page 140.	
				When configuring with a redundant measurement transducer, the adapter connects both measurement transducers.	
				When configuring without a measurement transducer, the adapter connects the output drive and the planetary gearbox.	

5 Planetary gearbox	Code	5GE19	5GE68
	Order no.	0 608 720 058	0 608 720 041
	Reduction	19.3	67.9
	Avg. efficiency	0.93	0.9
	Installation length	mm 154	188
	Weight	kg 2.9	3.7
6 Transverse gearbox	Code	5ULG	
	Order no.	0 608 810 039	
	Reduction	1	
	Avg. efficiency	0.95	
	Installation length	mm 63.8	
	Weight	kg 3.2	
		The transverse gearbox shortens the length of your tightening spindle by the installation length of the EC motor plus the installation length of the transverse gearbox.	
7 EC motor	Code	EC305	
	Order no.	0 608 701 019	
	Installation length	mm 304	
	Weight	kg 6.4	

Side-by-side arrangement of tightening spindles (center-to-center distance)						
Number of tightening spindles		2	3	4	5	6
						
Min. circle diameter- $\varnothing d_{\min}$ mm	G...	86	100	131	162	172

Tightening spindles size 5

Offset output drive



- ▶ Working range 50–1,000 Nm
- ▶ Max. output drive speed 515 rpm

Depending on the size, the actual components may differ from those in the illustration.

FEATURES

- ▶ For tight hole templates
- ▶ Standard tool mounts
- ▶ Maintenance-free for 1 million full-load cycles





Tightening spindle			Offset output drive			Measurement transducer	Planetary gearbox	EC motor
Working range Nm	Max. output drive speed rpm	Range of spring mm	Tool mount	Code	Order no.	Code/ Order no.	Code/ Order no.	Code/ Order no.
50*-148	515	80	3/4" square drive with centering pin	VNK3C281	0 608 800 543	5DMC530 0 608 820 116	5GE19 0 608 720 058	EC305 0 608 701 019
				VNK3C350	0 608 800 545			
				VNL3C418	0 608 800 548			
115*-365	200	80	1" square drive with centering pin	VUK3D316	0 608 PE0 017			
				VUK3D384	0 608 PE0 180			
50*-463	145	80	3/4" square drive with centering pin	VNK3C281	0 608 800 543		5GE68 0 608 720 041	
				VNK3C350	0 608 800 545			
				VNL3C418	0 608 800 548			
115*-1,000	55	80	1" square drive with centering pin	VUK3D316	0 608 PE0 017			
				VUK3D384	0 608 PE0 180			

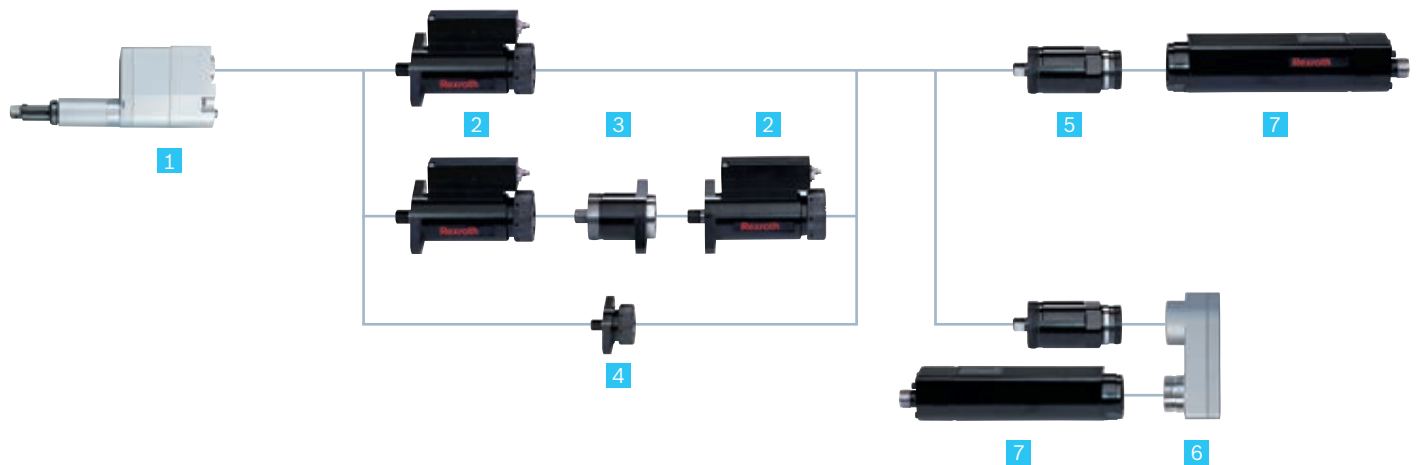

* Depending on the tolerance limits, position-based MCT required

Note: You can find component dimensions and 3D/CAD data on the Internet at www.boschrexroth.com/tightening





Offset output drive size 5 – components



1 Offset output drive 	Code	VNK3C281	VNK3C350	VNL3C418	VUK3D316	VUK3D384	
	Order no.	0 608 800 543	0 608 800 545	0 608 800 548	0 608 PE0 017	0 608 PE0 180	
	Max. torque	Nm	500	500	500	1,000	1,000
	Range of spring	mm	80	80	80	80	80
	Spring force	N	40–155	40–155	40–155	150–293	150–293
	Reduction		1	1	1	2.51	2.51
	Avg. efficiency		0.92	0.92	0.92	0.9	0.9
	Length A	mm	284	353	421	320	388
Installation length	mm	482	551	619	572	640	
Weight	kg	11.7	11.7	12.9	30	32	
2 Measurement transducer 	Code	5DMC530					
	Order no.	0 608 820 116			You can configure your tightening spindle with a redundant measurement transducer from the same type. Connect both measurement transducers with the redundant adapter. For measurement transducer cables, see page 140.		
	Nominal torque	Nm	530				
	Reduction		1				
	Avg. efficiency		1				
	Installation length	mm	125.5				
Weight	kg	3.7					
3 Redundant adapter 	Code	5AR					
	Order no.	0 608 810 023			When configuring with a redundant measurement transducer, the adapter connects both measurement transducers.		
	Reduction		1				
	Avg. efficiency		1				
	Installation length	mm	108				
Weight	kg	2.4					
4 Adapter 	Code	5A					
	Order no.	0 608 810 027			When configuring without a measurement transducer, the adapter connects the output drive and the planetary gearbox.		
	Reduction		1				
	Avg. efficiency		1				
	Installation length	mm	48.5				
Weight	kg	2.2					

5 Planetary gearbox 	Code	5GE19	5GE68
	Order no.	0 608 720 058	0 608 720 041
	Reduction	19.3	67.9
	Avg. efficiency	0.93	0.9
	Installation length	mm 154	188
	Weight	kg 2.9	3.7
6 Umlenkgetriebe 	Code	5ULG	
	Order no.	0 608 810 039	The transverse gearbox shortens the length of your tightening spindle by the installation length of the EC motor plus the installation length of the transverse gearbox.
	Reduction	1	
	Avg. efficiency	0.95	
	Installation length	mm 63.8	
	Weight	kg 3.2	
7 EC-Motor 	Code	EC305	
	Order no.	0 608 701 019	
	Installation length	mm 304	
	Weight	kg 6.4	

Side-by-side arrangement of tightening spindles (center-to-center distance)

Number of tightening spindles		2	3	4	5	6
						
Min. circle diameter- \varnothing d_{\min} mm	VN...	61	71	87	104	122
	VU...	94	108	133	159	187

Accessories for tightening spindles



ANGLE HEADS WITH OR WITHOUT STROKE
for size 4 and 5 tightening spindles – on request



**ANGLE HEADS WITH INTEGRATED MEASUREMENT
TRANSDUCER - ON REQUEST**



ANGLE HEADS WITH HOLD AND DRIVE
on request



BLOCK OUTPUT DRIVES
on request



SOCKET TRAYS

on request



PROGRAMM SELECTOR SWITCH

on request



FEED GRIPPERS

on request



TELESCOPIC SUSPENSION

on request

Customized solutions and projects



HANDLING DEVICES

with torque support for tightening spindles and ErgoSpin hand-held nutrunners



TELESCOPIC BALANCER

for fatigue-free work with hand-held tightening spindles thanks to low displacement resistance



WORKER GUIDES AND AUTOMATED SOLUTIONS
for all aspects of the tightening position

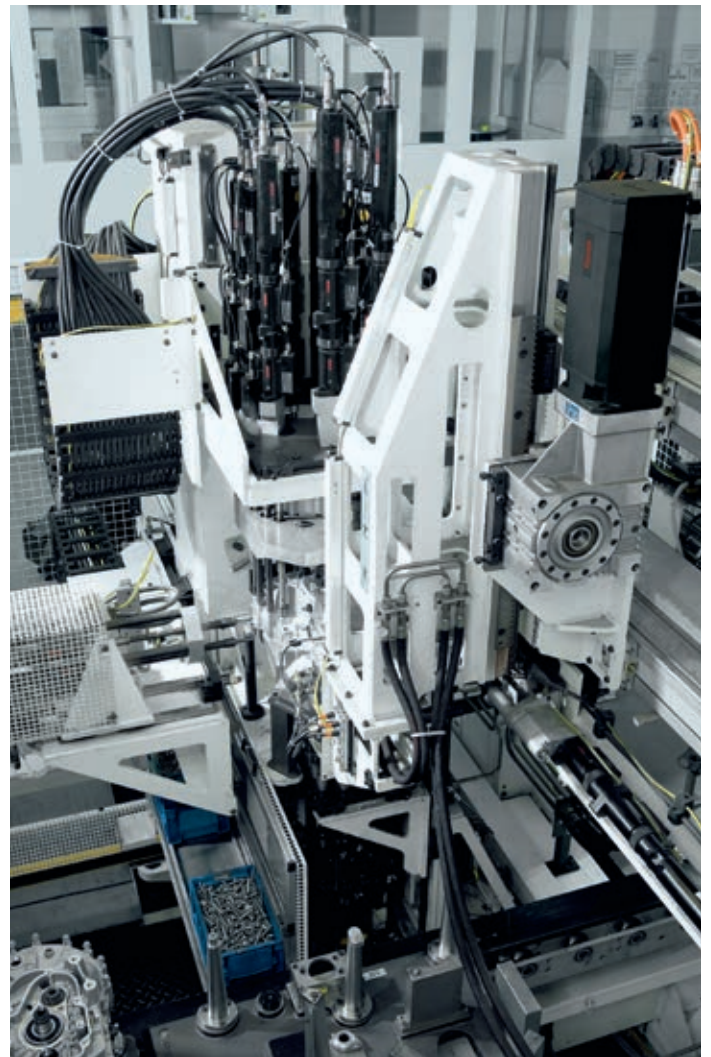

FULLY AUTOMATIC TIGHTENING STATIONS
also with nutrunner supply – that can be completely
integrated into production lines

Customized solutions and projects

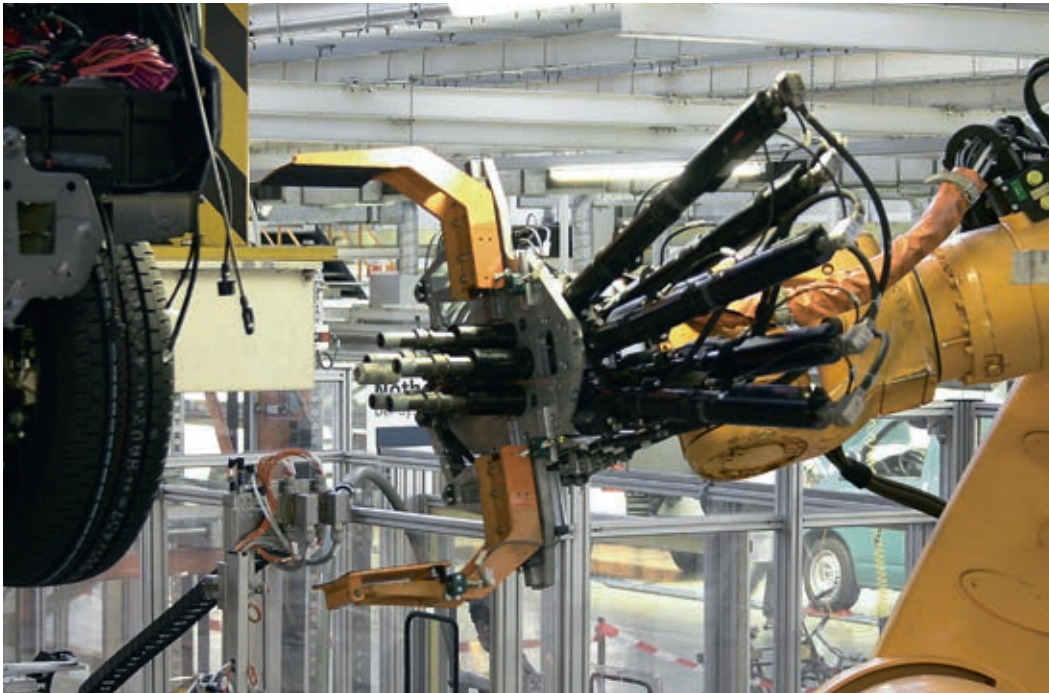

**ROBOT CONTROLLED
WHEEL MULTI**
for the automotive industry

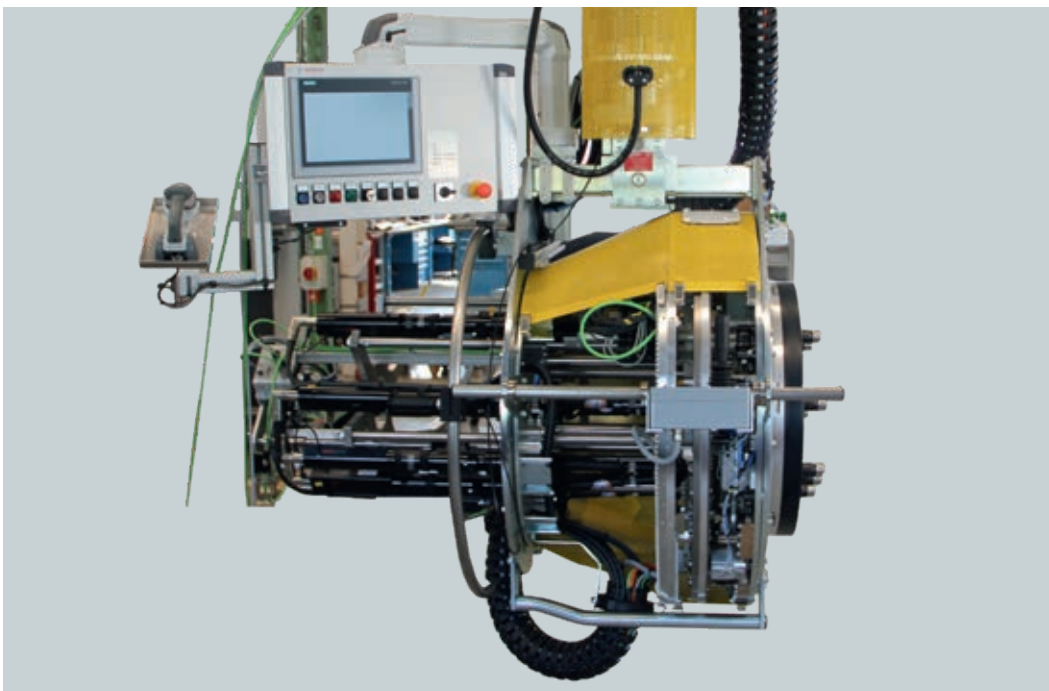

**8-SPINDLE REAR AXLE
MULTI**
with adjustable pitch
circle diameter and
integrated nut changer



AXLE NUT TIGHTENING



PLANETARY GEAR TIGHTENING

ErgoSpin – ergonomic, powerful, handy

The ErgoSpin is designed according to the latest findings in ergonomics and fits the user's hand like a glove. The ergonomics of the handle, its light weight, and the optimum arrangement of operating and display elements increase worker productivity. New: From now on, the angle compensation function can be activated by a license stick for all ErgoSpin hand-held nutrunners with an integrated measurement transducer.



- ▶ Fast commissioning
- ▶ Flexible stock-keeping: only 1 cable type for all variants
- ▶ Maximum precision thanks to digital data transfer

- ▶ Ergonomic handling due to a rubber-coated angle head with a safety flange
- ▶ Process reliability thanks to clearly arranged display elements
- ▶ CC-ErgoSpin variant for function-critical tightening jobs



VARIANT ESM

Pistolgrip nutrunner with integrated powerful LED for tightening position illumination



VARIANT GripLine

Right-angle nutrunner with plastic-covered angle head for protection against scratches and accidental contacts as well as a second grip



VARIANT SlimLine

Right-angle nutrunner with slim angle head for high accessibility



VARIANT VarioLine

Zero-play spur gearing for free connection of crowfoot wrenches and special output drives

Hand-held nutrunner

ESM ErgoSpin pistolgrip nutrunner for safety-critical tightening jobs



- ▶ With square tool mount, quick-change chuck, 1/4" or 3/8" square tool mount
- ▶ Working range 2.4 – 35 Nm
- ▶ Max. output drive speed 1,700 rpm
- ▶ With integrated measurement transducer
- ▶ Suitable for safety-critical tightening jobs in accordance with VDI/VDE 2862

FEATURES

- ▶ Pistolgrip nutrunner, also suitable for hard-to-reach tightening positions
- ▶ With integrated powerful LED
- ▶ Standard tool mounts
- ▶ Tested for one million cycles under full load without maintenance



ESM WITH SQUARE TOOL MOUNT

- ▶ Working range 2.4 – 35 Nm
- ▶ Max. output drive speed 1,700 rpm

Working range Nm	Max. output drive speed rpm	Tool mount	Weight kg	Installation length mm	Code	Order-no.
2.4–12	1,090	1/4" square drive	1	190	ESM012SD-G	0608841254
5–25	1,700	3/8" square drive	1.4	223	ESM025SD-G	0608841256
7–35	1,025	3/8" square drive	1.4	223	ESM035SD-G	0608841258



ESM WITH QUICK-CHANGE CHUCK TOOL MOUNT

- ▶ Working range 2.4 – 12 Nm
- ▶ Max. output drive speed 1,090 rpm

Working range Nm	Max. output drive speed rpm	Tool mount	Weight kg	Installation length mm	Code	Order-no.
2.4–12	1,090	1/4" quick-change chuck	1	201	ESM012QD-G	0608841255



ESM WITH 3/8" SQUARE TOOL MOUNT

- ▶ Working range 5 – 25 Nm
- ▶ Max. output drive speed 1,700 rpm

Working range Nm	Max. output drive speed rpm	Tool mount	Weight kg	Installation length mm	Code	Order-no.
5–25	1,700	3/8" square drive and zero play spur gearing for free connection of special output drives	1.4	223	ESM025HT-G	0608841257

Note: For special output drives and planetary gearboxes suitable for the ErgoSpin, see "Accessories for ErgoSpin / CC-ErgoSpin hand-held nutrunners" on page 94.

Hand-held nutrunner ErgoSpin GripLine for safety-critical tightening jobs



- ▶ Working range 1 – 75 Nm
- ▶ Max. output drive speed 1,000 rpm
- ▶ With integrated measurement transducer
- ▶ Suitable for safety-critical tightening jobs in accordance with VDI/VDE 2862

FEATURES

- ▶ Standard tool mounts
- ▶ Integrated LEDs visible all around
- ▶ Tested for one million cycles under full load without maintenance

Working range	Max. output drive speed	Tool mount	Weight	Installation length	Code	Order no.
Nm	rpm		kg	mm		
1–5	1,000	1/4" square drive	1.3	385	ESA005G-G	0608841224
2.6–13	1,000	1/4" square drive	1.3	385	ESA013G-G	0608841225
6–30	800	3/8" square drive	1.6	423.5	ESA030G-G	0608841226
8–40	1,000	3/8" square drive	1.8	437	ESA040G-G	0608841227
11–56	710	3/8" square drive	1.9	453	ESA056G-G	0608841228
13–65	610	1/2" square drive	1.9	453	ESA065G-G	0608841229
15–75	530	1/2" square drive	2.1	454	ESA075G-G	0608841230

Hand-held nutrunner ErgoSpin SlimLine for safety-critical tightening jobs



- ▶ Working range 1 – 220 Nm
- ▶ Max. output drive speed 1,000 rpm
- ▶ With integrated measurement transducer
- ▶ Suitable for safety-critical tightening jobs in accordance with VDI/VDE 2862

FEATURES

- ▶ Angle head has a non-interchangeable code and can be turned and locked in 15-degree steps
- ▶ Integrated LEDs visible all around
- ▶ Tested for one million cycles under full load without maintenance

Working range	Max. output drive speed	Tool mount	Weight	Installation length	Code	Order no.
Nm	rpm		kg	mm		
1–5	1,000	1/4" square drive	1.3	382	ESA005S-G	0608841204
2.6–13	1,000	1/4" square drive	1.3	382	ESA013S-G	0608841205
6–30	800	3/8" square drive	1.6	416	ESA030S-G	0608841206
8–40	1,000	3/8" square drive	1.7	434	ESA040S-G	0608841207
11–56	710	3/8" square drive	1.9	446	ESA056S-G	0608841208
13–65	610	1/2" square drive	1.9	448	ESA065S-G	0608841209
15–75	530	1/2" square drive	2	450	ESA075S-G	0608841210
20–100	630	1/2" square drive	3.1	492	ESA100S-G	0608841211
30–150	380	1/2" square drive	3.8	531	ESA150S-G	0608841212
44–220	260	3/4" square drive	4	541	ESA220S-G	0608841213

Hand-held nutrunner ErgoSpin VarioLine for safety-critical tightening jobs



- ▶ Working range 1 – 146 Nm
- ▶ Max. output drive speed 1,700 rpm
- ▶ With integrated measurement transducer
- ▶ Suitable for safety-critical tightening jobs in accordance with VDI/VDE 2862

FEATURES

- ▶ Extended application options in combination with handling devices and special output drives (e.g. crowfoot wrenches)
- ▶ Can be used as a tightening spindle with output drive adapters
- ▶ Fully suitable for robot use
- ▶ Tested for one million cycles under full load without maintenance

Working range Nm	Max. output speed drive rpm	Tool mount	Weight kg	Installation length mm	Code	Order no.
1–5	1,090	Standard machine with an output with zero-play spur gearing for the attachment of special output drives	1.1	333	ESV005-G	0608841243
2.4–12	1,090		1.1	333	ESV012-G	0608841244
5–25	1,700		1.4	365	ESV025-G	0608841245
10–50	830		1.5	375	ESV050-G	0608841246
14–73	900		2.4	406	ESV073-G	0608841247
29–146	420		2.8	430	ESV146-G	0608841248

Hand-held nutrunner ESM CC-ErgoSpin pistolgrip nutrunner for function-critical tightening jobs



- ▶ Working range 2.4 – 25 Nm
- ▶ Max. output drive speed 1,700 rpm
- ▶ Current-controlled nutrunner
- ▶ Suitable for function-critical tightening jobs in accordance with VDI/VDE 2862

FEATURES

- ▶ With integrated powerful LED
- ▶ Standard tool mounts
- ▶ Tested for one million cycles under full load without maintenance

Working range	Max. output speed drive	Tool mount	Weight	Installation length	Code	Order no.
Nm	1/min		kg	mm		
2.4 – 12	1,090	1/4" quick-change chuck	1	201	CC-ESM012QD	0608 841 089
5 – 25	1,700	3/8" square drive and zero-play spur gearing for free connection of special output drives	1.4	223	CC-ESM025HT	0608 841 094

Note: For special output drives and planetary gearboxes suitable for the ErgoSpin, see "Accessories for ErgoSpin / CC-ErgoSpin hand-held nutrunners" on page 94.

Hand-held nutrunner CC-ErgoSpin SlimLine for function-critical tightening jobs



- ▶ Working range 6–100 Nm
- ▶ Max. output drive speed 1,000 rpm
- ▶ Current-controlled nutrunner
- ▶ Suitable for function-critical tightening jobs in accordance with VDI/VDE 2862

FEATURES

- ▶ Angle head has a non-interchangeable code and can be turned and locked in 15-degree steps
- ▶ Integrated LEDs visible all around
- ▶ Tested for one million cycles under full load without maintenance

Working range	Max. output drive speed	Tool mount	Weight	Installation length	Code	Order no.
Nm	1/min		kg	mm		
6–30	800	3/8" square drive	1.6	416	CC-ESA030S	0608841087
8–40	1,000	3/8" square drive	1.7	434	CC-ESA040S	0608841088
20–100	630	1/2" square drive	3.1	492	CC-ESA100S	0608841092

Hand-held nutrunner CC-ErgoSpin VarioLine for function-critical tightening jobs



- ▶ Working range 2.4 – 146 Nm
- ▶ Max. output drive speed 1,090 rpm
- ▶ Current-controlled nutrunner
- ▶ Suitable for function-critical tightening jobs in accordance with VDI/VDE 2862

FEATURES

- ▶ Extended application options in combination with handling devices and special output drives
- ▶ Can be used as a tightening spindle with output drive adapters
- ▶ Fully suitable for robot use
- ▶ Integrated LEDs visible all around
- ▶ Tested for one million cycles under full load without maintenance

Working range	Max. output drive speed	Tool mount	Weight	Installation length	Code	Order no.
Nm	1/min		kg	mm		
2.4 – 12	1,090	Standard machine with an output with zero-play spur gearing for the attachment of special output drives	1.1	333	CC-ESV012	0608841090
10 – 50	830		1.5	376	CC-ESV050	0608841093
29 – 146	420		2.8	430	CC-ESV146	0608841091

Output drives for ErgoSpin/CC-ErgoSpin VarioLine

In combination with handling devices and output adapters the hand-held nutrunner VarioLine becomes a tightening spindle. This offers extended application options and makes it fully suitable for robot use.

ANGLE HEADS

You can mount different angle heads on the ErgoSpin VarioLine. This makes your ErgoSpin hand-held nutrunner suitable for a variety of applications.

With an angle head for special output drives, you can e.g. mount a crowfoot wrench to the VarioLine.

VarioLine COMBINATION OPTIONS WITH ANGLE HEADS



ErgoSpin VarioLine Code	Code	Tool mount	Weight kg	Max. torque** Nm	Reduction	Avg. efficiency	Order no.
ESV005/ CC-ESV005	WH013S	1/4" square drive	0.2	13	1.1	0.95	3608876051
	WH013G*	1/4" square drive	0.2	13	1.1	0.95	3608876052
ESV012/ CC-ESV012	WH013S	1/4" square drive	0.2	13	1.1	0.95	3608876051
	WH013G*	1/4" square drive	0.2	13	1.1	0.95	3608876052
ESV025	WH040S	3/8" square drive	0.4	40	1.73	0.95	3608876055
	WH040G*	3/8" square drive	0.4	40	1.73	0.95	3608876056
ESV050/ CC-ESV050	WH056S	3/8" square drive	0.5	56	1.16	0.95	3608876057
	WH056G*	3/8" square drive	0.6	56	1.16	0.95	3608876058
	WH065S	1/2" square drive	0.5	65	1.35	0.95	3608876059
	WH065G*	1/2" square drive	0.7	65	1.35	0.95	3608876060
	WH075S	1/2" square drive	0.5	75	1.56	0.95	3608876061
	WH075G*	1/2" square drive	0.7	75	1.56	0.95	3608876062
ESV073	WH100S	1/2" square drive	0.7	100	1.42	0.95	3608876063
ESV0146/ CC-ESV146	WH150S	1/2" square drive	1.0	150	1.1	0.95	3608876064
	WH220S	3/4" square drive	1.3	220	1.59	0.95	3608876065



ErgoSpin VarioLine Code	Code	Tool mount	Weight kg	Max. torque** Nm	Reduction	Avg. efficiency	Order no.
ESV025	WHS040	3/8" square drive	0.5	40	1.73	0.95	3608876081
ESV050/ CC-ESV050	WHS075	1/2" square drive	0.7	75	1.56	0.95	3608876082
ESV073	WHS100	1/2" square drive	0.9	100	1.42	0.95	3608876083

* Plastic-covered titanium angle head as a second grip

** Value refers to angle head

STRAIGHT OUTPUT DRIVES

Straight output drives combined with the ErgoSpin VarioLine produce a straight nutrunner. The combination of VarioLine and straight output drives supplies an ergonomic

solution for tightening cases of up to 12 Nm: whether vertically suspended, as a hand-held straight nutrunner, a hand-held application, or in connection with handling devices.

VarioLine COMBINATION OPTIONS WITH STRAIGHT OUTPUT DRIVES*



ErgoSpin VarioLine Code	Working range Nm	Tool mount	Reduction	Avg. efficiency	Installation length mm	Weight kg	Code	Order no.
ESV005	1–5	1/4" square drive	1	1	31.5	0.1	ESISA012	0608810047
	1–5	1/4" quick-change chuck	1	1	31.5	0.1	ESIQA012	0608810048
ESV012/ CC- ESV012	2.4–12	1/4" square drive	1	1	31.5	0.1	ESISA012	0608810047
	2.4–12	1/4" quick-change chuck	1	1	31.5	0.1	ESIQA012	0608810048

OUTPUT DRIVE ADAPTERS

With the output drive adapters, you can combine the ErgoSpin VarioLine with output drives in sizes 2, 3, and 4 for tightening spindles and e.g. use it as a tightening spindle.

VarioLine COMBINATION OPTIONS WITH OUTPUT DRIVE ADAPTERS*



ErgoSpin VarioLine Code	Working range Nm	Tool mount	Reduction	Avg. efficiency	Installation length mm	Weight kg	Code	Order no.
ESV005	1–5	Size 2	1	1	41.4	0.1	ESOA012	0608810049
ESV012/ CC-ESV012	2.4–12	Size 2	1	1	41.4	0.1	ESOA012	0608810049
ESV025	5–25	Size 3	1	1	40.3	0.1	ESOA025	0608810050
ESV050/ CC-ESV050	10–50	Size 3	1	1	41.2	0.2	ESOA050	0608810051
ESV073	14–73	Size 4	1	1	44.5	0.3	ESOA073	0608810052
ESV146/ CC-ESV146	29–146	Size 4	1	1	44	0.3	ESOA146	0608810053

* Special output drives on request

Accessories for ErgoSpin / CC-ErgoSpin hand-held nutrunners



HOLDER FOR RIGHT-ANGLE NUTRUNNER AND STRAIGHT NUTRUNNER

Code	Order no.
ESAT	3608876626

PRESENCE DETECTION SENSORS

On request



HOLDER FOR ESM PISTOLGRIP NUTRUNNER

Code	Order no.
ESMT	3608877433

PRESENCE DETECTION SENSORS

On request



TURNING SUSPENSION

Code	Ø mm	ErgoSpin	Order no.	Weight g
ESMH1	50	ESA005-075	3608875426	100
		ESV005-050		
ESMH2	63	ESA100-220	3608875921	145
		ESV073-146		

TURNING SUSPENSION WITH EXTENSION

On request



SUSPENSION FOR ERGOSPIN PISTOLGRIP NUTRUNNER

Code	Order no.
ESMB	3608876767



EXTENSION

Code	Installation length mm	ErgoSpin	Order no.
ESET040	200	ESA040 / ESV025	On request
ESET056	250	ESA056 / ESV050	
ESET065	250	ESA065 / ESV050	
ESET075	250	ESA075 / ESV050	
ESET100	250	ESA100 / ESV073	



EXTRA GRIP

Code	ErgoSpin	Order no.
ESMH12	ESM012SD, ESM012QD	3 608 877 111
ESMH25	ESM025SD, ESM025HT, ESM035SD	3 608 877 112



VERTICAL SUSPENSION

Code	ErgoSpin	Order no.	Weight g
ESMV	ESA / ESV	3 608 875 435	180

START LEVER EXTENSION FOR STRAIGHT NUTRUNNERS INCL. VERTICAL SUSPENSION

Code	ErgoSpin	Order no.	Weight g
ESTE	ESA005-075 ESV005-050	3 608 876 175	235

Accessories for ErgoSpin / CC-ErgoSpin hand-held nutrunners



STROKE EXTENSION

Code	Order no.
ESSE	3608876746



ADAPTER WITH HOLES FOR HANDLING DEVICES

Code	ErgoSpin	Order no.
ESCU1B	ESA005-075, ESV005-050	3608876459
ESCU2B	ESA100-220, ESV073-146	3608876409



ADAPTER WITHOUT HOLES FOR HANDLING DEVICES

Code	ErgoSpin	Order no.
ESCU1F	ESA005-075, ESV005-050	3608876751
ESCU2F	ESA100-220, ESV073-146	3608876749



TORQUE SUPPORT WITH OR WITHOUT TOOL BALANCER

On request

You can choose from a large number of variants. The torque supports differ in drive direction (vertical/horizontal), extension length and torque range.



SOCKET TRAY

On request

You can choose from a large number of variants. The socket trays are available with four or eight slots and can be expanded to up to 32 slots with additional modules. The following connection variants are available: fieldbus connections (PROFIBUS, PROFINET, Ethernet/Open Modbus UDP/TCP), 24V I/O, Open Protocol and WiFi.



ERGOSPIN WITH INTEGRATED SCANNER

On request



PLANETARY GEARBOXES FOR HIGH TORQUES UP TO 1,000 NM

On request



CROWFOOT WRENCH FOR ERGOSPIN NUTRUNNERS

On request

Accessories for ErgoSpin / CC-ErgoSpin hand-held nutrunners



PROGRAM SELECTOR SWITCH

On request

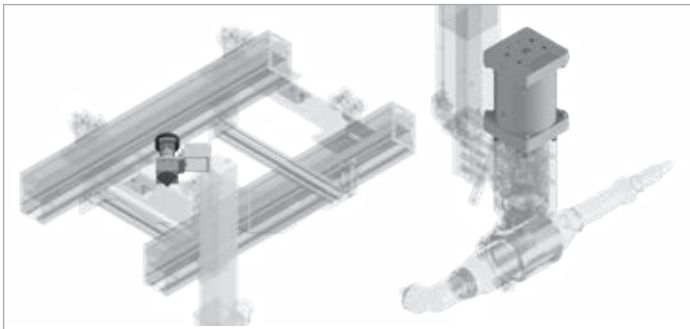

BRAKES

On request



HANDLING DEVICES

On request

Angle compensation function

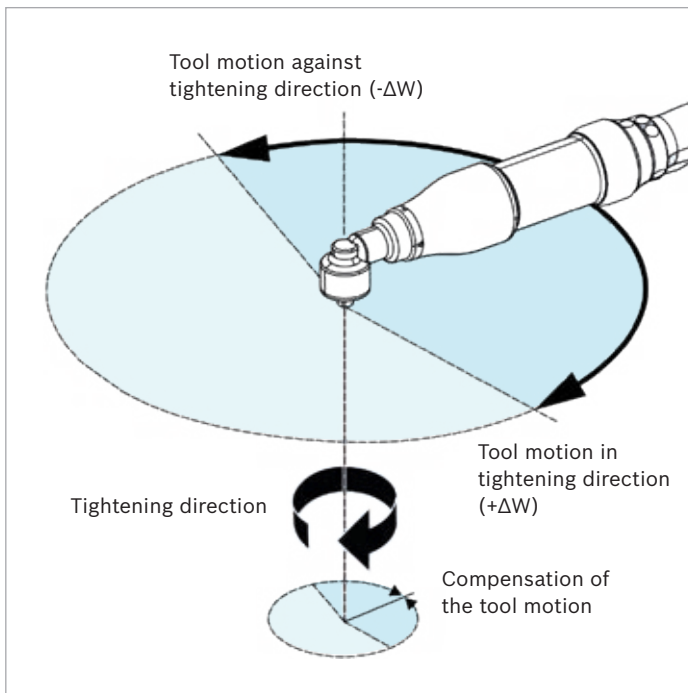

FUNCTIONALITY

- ▶ Functionality available for all new ErgoSpin hand-held nutrunners
- ▶ Compensation of worker movement with triaxial sensors in real-time
- ▶ Measurement and output of the programmed actual angle of turn values
- ▶ Improvement of the joint quality especially in connection with angle-controlled target functions
- ▶ No alignment of the Bosch gyro sensor required thanks to triaxial sensor system



LICENSE STICK

The angle compensation function is available for the Rexroth Tightening System 350 from software version V2.500 upwards. Activating the angle compensation function requires a license, which is available on a license stick. Each license stick contains exactly one license for a tightening channel. The license stick must be plugged into the corresponding control unit (interface X3U1, X3U2) for the function to be executed.

FREE DEMO PERIOD

The angle compensation function can be tested for a maximum period of 30 days without licensing. Activation is only possible once for each channel on each controller.

NOTE

It is possible to make changes to the angle head setting. Information on this can be found in the configuration description.

LICENSE STICK

Code		Order no.
LS-ESG	1 x License	0 608 830 307

Nexo – intelligent cordless nutrunners

Rexroth intelligent cordless nutrunners join wireless technology with all the advantages of the proven ErgoSpin hand-held nutrunner for all category A safety-critical tightening jobs in accordance with VDI 2862: Direct measurement of control and monitoring values and the storing of the fastening results for record keeping purposes.



- ▶ Fits easily into the existing infrastructure of any production environment
- ▶ Integrated controller
- ▶ Direct communication between the line PLC and the data collection server
- ▶ Protection class: IP40

Nexo cordless nutrunner

NXP pistolgrip nutrunner



- ▶ Working range 1.8–12 Nm
- ▶ Max. output drive speed 880 rpm
- ▶ Suitable for safety-critical tightening jobs in accordance with VDI/VDE 2862

FEATURES

- ▶ For troublefree working at hard-to-reach tightening positions
- ▶ Ergonomic design and maximum freedom of movement
- ▶ Graphic display: direct values of the tightening results, program selection, and process information
- ▶ Process reliability even without a connection to the WiFi network

Working range	Max. output drive speed	Tool mount	Weight without battery ¹	Installation length without battery ¹	Code	Order no.
Nm	rpm		kg	mm		
1.8–12	880	1/4" quick-change chuck	1.34	237	NXP012QD-36V	0608842005
1.8–12	880	1/4" quick-change chuck	1.34	237	NXP012QD-36V-B ²	0608842010

NOTE

Supply of Nexo cordless nutrunner without battery pack.
For slide-in battery pack see page 106.

¹ Weight of battery: 0.7 kg
Length of battery: 86 mm

² With integrated barcode scanner

Nexo cordless nutrunner

NXA right-angle nutrunner



- ▶ Working range 3–65 Nm
- ▶ Max. output drive 850 rpm
- ▶ Suitable for safety-critical tightening jobs in accordance with VDI/VDE 2862

FEATURES

- ▶ With slim angle head for high accessibility
- ▶ Graphic display: direct values of the tightening results, program selection, and process information
- ▶ Process reliability even without a connection to the WiFi network

Working range Nm	Max. output drive speed rpm	Tool mount	Weight without battery ¹ kg	Installation length without battery ¹ mm	Code	Order no.
3–11	850	3/8" square drive	1.56	442	NXA011S-36V	0608842011
3–11	850	3/8" square drive	1.56	442	NXA011S-36V-B ²	0608842012
3–15	600	3/8" square drive	1.56	442	NXA015S-36V	0608842001
3–15	600	3/8" square drive	1.56	442	NXA015S-36V-B ²	0608842006
6–30	310	3/8" square drive	1.99	534	NXA030S-36V	0608842002
6–30	310	3/8" square drive	1.99	534	NXA030S-36V-B ²	0608842007
10–50	185	3/8" square drive	2.03	534	NXA050S-36V	0608842003
10–50	185	3/8" square drive	2.03	534	NXA050S-36V-B ²	0608842008
13–65	135	3/8" square drive	2.03	534	NXA065S-36V	0608842013
13–65	135	3/8" square drive	2.03	534	NXA065S-36V-B ²	0608842014

¹ Weight of battery: 0.7 kg; length of battery: 86 mm

² With integrated barcode scanner

NOTE

Supply of Nexo cordless nutrunner without battery pack.
For slide-in battery pack see page 106.

Nexo cordless nutrunner

NXV VarioLine nutrunner



- ▶ Working range basic machine 1.8–12 Nm
- ▶ Working range with angle head 3–15 Nm
- ▶ Max. output drive of basic machine 880 rpm
- ▶ Max. output drive with angle head 600 rpm
- ▶ Suitable for safety-critical tightening jobs in accordance with VDI/VDE 2862

FEATURES

- ▶ With slim angle head for high accessibility
- ▶ Graphic display: direct values of the tightening results, program selection, and process information
- ▶ Process reliability even without a connection to the WiFi network

Working range Nm	Max. output drive speed rpm	Tool mount	Weight without battery ¹ kg	Installation length without battery ¹ mm	Code	Order no.
3–15/1.8–12 ²	600/880 ²	Basic machine with an output with thread and pin for the attachment of special output drives	1.56/1.35 ²	442	NXV012T-36V	0608842015
3–15/1.8–12 ²	600/880 ²		1.56/1.35 ²	442	NXV012T-36V-B ³	0608842016

¹ Weight of battery: 0.7 kg; length of battery: 86 mm

² Values without output drive

³ With integrated barcode scanner

NOTES

Supply of basic machine with angle head.
Supply of Nexo cordless nutrunner without battery pack.
For slide-in battery pack see page 106.

Nexo

Angle heads



Code	Suitable for	Tool mount	Weight kg	Max. torque* Nm	Gear ratio	Avg. efficiency	Order no.
NXAH11-15	NXA011S-36V/-B NXA015S-36V/-B	3/8" square drive	1.56	15	1.4	0.94	0 608 843 022
NXAH30	NXA030S-36V/-B	3/8" square drive	1.56	30	5.25	0.94	0 608 843 023
NXAH50-65	NXA050S-36V/-B NXA065S-36V/-B	3/8" square drive	1.56	65	6.363636	0.94	0 608 843 024

* Value refers to angle head

Nexo

Accessories and extensions



MOUNTING AID FOR ANGLE HEADS

Code	Suitable for	Order no.
ESWM	NXA030S-36V NXA050S-36V NXA065S-36V	3 608 876 473



PROTECTIVE CAP FOR ANGLE HEADS

Code	Suitable for	Quantity	Order no.
NXAPAH2	NXA030S-36V	5	0 608 843 015
	NXA050S-36V		
	NXA065S-36V		



PROTECTIVE CAP FOR ANGLE HEADS

Code	Suitable for	Quantity	Order no.
NXAPAH1	NXA011S-36V	5	0 608 843 016
	NXA015S-36V		



PROTECTIVE INSULATION FOR BATTERY ASSEMBLY

Code	Suitable for	Tool mount	Max. torque	Order no.
NXPP012	NXP12QD-36V	1/4" quick-change chuck	12 Nm	0 608 843 012



PROTECTIVE INSULATION FOR BATTERY ASSEMBLY

Code	Suitable for	Tool mount	Max. torque	Order no.
NXAP030	NXA030S-36V	3/8" square drive	30 Nm	0 608 843 011
	NXA050S-36V			
	NXA065S-36V			

Nexo – accessories and extensions



SLIDE-IN BATTERY PACK

Code	Quantity	Order no.
NX-BP2-36V	1	0608843019



SIMPLE CHARGER

Code	Voltage	Order no.
NX-BC36V	100V-240V (~50-60Hz)	0608843002

Battery charging cabinets for Rexroth slide-in battery packs on request



PROGRAMMING ADAPTER*

Code	Order no.
NX-A3	0608843021

* Adapter supplied without Ethernet cable



MICRO SD CARD

Code	Order no.
NX-SD	0608843005



HOLDER FOR RIGHT-ANGLE NUTRUNNERS

Code	Order no.
ESAT	3608876626

On request with sensors for tool detection



HOLDER FOR PISTOLGRIP NUTRUNNERS

Code	Order no.
NXPT	0608843008

Note: Cannot be used for pistolgrip nutrunners with protective insulation for battery assembly



TURNING SUSPENSION FOR RIGHT-ANGLE NUTRUNNERS

Code	Order no.
NXAMT	0608843003

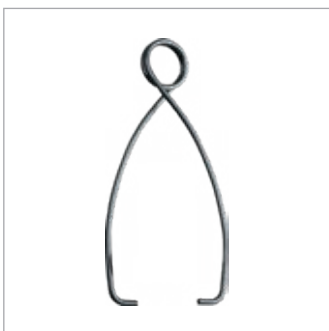

SUSPENSION FOR PISTOLGRIP NUTRUNNERS

Code	Order no.
NXPB	0608843004

Nexo – accessories and extensions



EXTRA GRIP FOR PISTOLGRIP NUTRUNNERS

Code	Order no.
NXPH	0608843009

Note: Cannot be used for pistol-grip nutrunners with protective insulation for battery assembly.



ASSORTED COLORED RINGS

Code	Quantity	Order no.
NX-R	21 (3 pieces of each color)	0608843010



NEXO BRACKET FOR SUPPORT SYSTEMS (E. G. POSITIONING SENSORS)

Code	Quantity	Order no.
NX-HD	2	0608843018



ACCESS POINT*

Code	Order no.
NX-ACCESS	0608843007

* Without power supply unit.

Nexo

Browser-based operating software NEXO-OS

- ▶ Easy set-up as additional software installation is not necessary. Operating software can be used without local installation.
- ▶ Independence from end devices provides complete flexibility. Access to the browser-based software is not dependent on operating system nor end device.
- ▶ You can access the Nexo software by using any web-browser enabled device.
- ▶ Easy to learn, easy to use: Programming of individual tightening tasks is simple via the intuitive graphic user interface.
- ▶ Scalable user rights



Control and power electronics

The hardware platform is based on cutting-edge technology and thus ensures investment security. It has been specially developed for industrial applications. The system box and compact system fully comply with the IP54 protection class.



- ▶ Compact and powerful
- ▶ Secure and fast commissioning
- ▶ Sturdy: IP54
- ▶ Combination of tightening spindles/ErgoSpin
- ▶ Well arranged control and display elements
- ▶ Flexible connection to control and archive systems
- ▶ High process reliability due to internal self-diagnostics



Maximum flexibility in controller configuration – here are just some of the many options:

1

One nutrunner – multiple nutrunners?

COMPACT SYSTEM OR MODULAR SYSTEM

- ▶ 1 tightening channel = CS351 Compact System page 112
- ▶ 2 to 40 tightening channels = 350 Modular System page 118

2

350 Modular System – where to store the system components?

BT CARD RACK OR SB SYSTEM BOX

- ▶ The card rack is designed for installation in a control cabinet.
- ▶ Tightening systems without control cabinets are possible with the system box.

3

Universal communication – the KE communication unit

CONFIGURATION OF THE FIRST BT CARD RACK/FIRST SB SYSTEM BOX

- ▶ VM power supply module
- ▶ KE communication unit
- ▶ SE control units Max. 3 SE per BT/SB
- ▶ LTS/LTE servo amplifiers (tightening spindle/ErgoSpin respectively) Max. 5 LTS/LTE per BT/SB

4

1, 2, 3... and many more

CONNECTING MULTIPLE BT CARD RACKS/SB SYSTEM BOXES

- ▶ Multiple BT/SB are connected to NK network couplers. Configuration from 2nd BT/SB:
- ▶ No KE is required from the 2nd BT/SB upwards. Max. 3 SE pro BT/SB
- ▶ Another LTS/LTE can be inserted in its position. Max. 6 LTS/LTE per BT/SB

CS351 Compact System

The operating and display units, as well as the connections, are arranged in a userfriendly, modern, and convincing design. The clear structure of the CS351 allows intuitive operation without any complicated configuration.

The housing, which is not larger than a minitower, fully complies with protection class IP54. Its compact interior combines power electronics and Ethernet-based bus systems with the new highperformance 350 control generation.

FEATURES

- ▶ Compact and powerful
- ▶ Clear system design
- ▶ Secure and fast commissioning
- ▶ Tightening results at a glance, including curves
- ▶ Clearly arranged control and display elements
- ▶ Sturdy: IP54, EMC severity level IV
- ▶ USB and Ethernet-based bus systems
- ▶ Flexible adaptation to new tasks





CS351 Compact System – model variants



COMPACT SYSTEM CS351...-G... HIGH-QUALITY TFT WITH TOUCH SCREEN AND LARGE VIEWING ANGLE

- ▶ Resolution: 640x480
- ▶ Display size: 6.5 inches
- ▶ Actual value display
- ▶ Tightening graph display
- ▶ Parameter changes
- ▶ Ethernet on board
- ▶ Tightening program selection

COMPACT SYSTEM CS351...-D... DISPLAY VERSION WITH DVI INTERFACE

- ▶ Actual value display
- ▶ Connection to external DVI monitor and input unit
- ▶ Ethernet on board

Compact System for	Code	Weight kg	Order no.
ErgoSpin	CS351E-G	9.7	0 608 830 258
	CS351E-D	9.5	0 608 830 257
	CS351E-G IL	9.7	0 608 830 275
	CS351E-D IL	9.5	0 608 830 274
	CS351E-D NK	9.9	0 608 830 281
Tightening spindle	CS351S-G	9.7	0 608 830 255
	CS351S-D	9.5	0 608 830 254
	CS351S-G IL	9.7	0 608 830 277
	CS351S-D IL	9.5	0 608 830 276
	CS351S-D NK	9.9	0 608 830 282

Note: For cable selection, see "Rexroth cables" from page 136.

CS351

- ▶ Dimensions (H x W x D): 358 x 210 x 253 mm
- ▶ Very easy suspension, even in tight areas
- ▶ Hinged, removable interface cover
- ▶ Highly flexible and future-proof due to interface modules
- ▶ IP54 protection class
- ▶ 120 V* and 230 V power supply
- ▶ Mains connection cable for 230 V included in the scope of delivery
- ▶ Motor stop interface
- ▶ RCD with CS351E-...
- ▶ Exchange connection cable – without tools

* The speed of size 5 motors is 15% lower with an operating voltage of 120 V than with an operating voltage of 230 V. The torque of the size 5 motors is 30% lower with an operating voltage of 120 V than with an operating voltage of 230 V.

CS351...IL

- ▶ Integrated logic
- ▶ Flexible programming according to IEC 61131-3
- ▶ Easy automation for the entire tightening process

CS351...NK

- ▶ Can be connected as an additional tightening channel to the KE350/KE350G IL via the network coupler cable
- ▶ Complete system bus diagnosis
- ▶ Central data output via the KE350/KE350G IL

NOTE

You can find the technical data for the Rexroth control electronics in the assembly instruction:

www.boschrexroth.com/tightening.

CC-CS351 Compact System for CC-ErgoSpin



- ▶ For CC-ErgoSpin hand-held nutrunner control
- ▶ Use in function and un-critical tightening applications according to classes B and C of VDI/VDE 2862

FEATURES

- ▶ Secure and fast commissioning
- ▶ Tightening results at a glance
- ▶ Sturdy: IP54, EMC severity level IV
- ▶ USB and Ethernet interface
- ▶ Clear system design
- ▶ Flexible adaptation to new tasks
- ▶ Clearly arranged control and display elements
- ▶ System not fieldbus capable; 24V I/O

NOTE

You can find the technical data for the Rexroth control electronics in the assembly instruction:

www.boschrexroth.com/tightening.

Compact System for	Code	Weight kg	Order no.
CC-ErgoSpin	CC-CS351E-D	9.5	0 608 830 289

Slots and connections

To ensure that the tightening system optimally matches your control environment today and in the future, it features three slots for interface modules, which are covered with dummy panels at the factory.

The CS351E-D... and CS351S-D... Compact Systems have an additional DVI interface to connect an external monitor and a corresponding USB feedback channel.

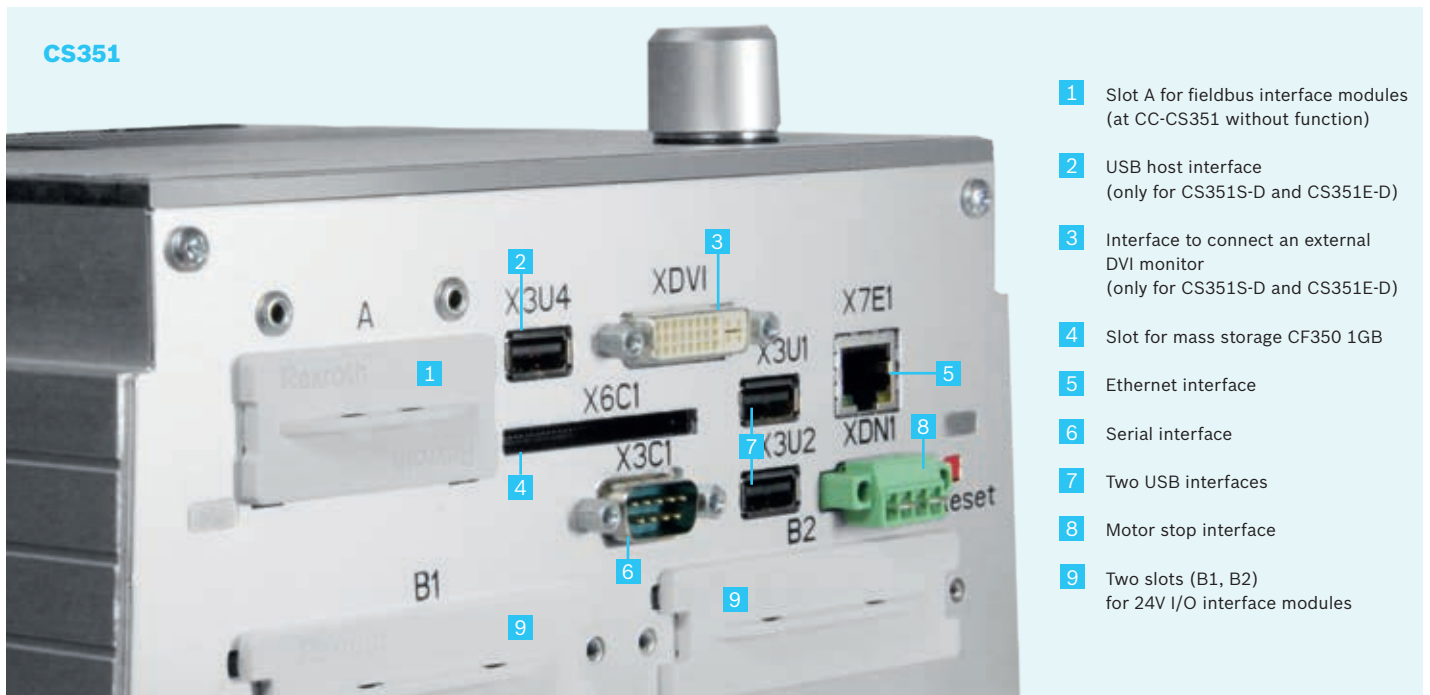

Slot	Fieldbus / description	Code	Order no.	Page
A	PROFIBUS DP	IMpdp	0 608 830 266	134
	DeviceNet	IMdev	0 608 830 267	134
	PROFINET IO	IMpnio	0 608 830 272	134
	PROFINET IO	IMpnio2	0 608 830 312	134
	EtherCat	IMecat	0 608 830 302	135
	Ethernet/IP	IMenip	0 608 830 271	135
	Ethernet/IP	IMenip2	0 608 830 313	135
	Modbus TCP	IMmtcp	0 608 830 273	135
B	24V I/O interface	IM24V	0 608 830 259	135
X6C1	Mass storage	CF350 1GB	0 608 830 318	129
XDAC1 / XDAC2	Network coupler cable	NKL0.6	3 608 877 369	139/143
		NKL002	3 608 877 370	
		NKL005	3 608 877 371	
		NKL010	3 608 877 372	
		NKLF*	3 608 877 373 /...	

Note: For cable selection, see "Rexroth cables" from page 136.

Modular System



- ▶ Multi-channel tightening system
- ▶ Can be upgraded to up to 40 tightening channels
- ▶ Combination of tightening spindles/ErgoSpin
- ▶ Uncomplicated programming
- ▶ Either in card rack or system box
- ▶ Convenient installation thanks to modularity



The splash-proof SB356 system box is intended for operation without a control cabinet in an industrial environment.



The BT356 card rack is intended for installation in control cabinets.

The SB356 system box and the BT356 card rack, made from durable stainless steel, are required in the modular system to support the control and power electronics.

Besides the VM350 power supply module, the BT/SB can also be equipped with up to six tightening channels. The tightening channels comprise an SE352 or SE352M control unit that controls up to two LTS350D servo amplifiers for tightening spindles or LTE350D servo amplifiers for ErgoSpin hand-held nutrunners. Mixed operation of tightening spindles and ErgoSpin on a SE352 or SE352M is possible at any time.

The KE350 or KE350G IL communication unit is responsible for internal and external system communication. It is inserted in the outermost BT/SB slot, instead of the sixth servo amplifier.

When the KE350 or KE350G IL is inserted in the first SB or the first BT, up to 16 BT/SB can be connected via the NK350 or NK350S network coupler and NKL network coupler cables.

The flexibly programmable logic integrated in the KE350G IL is in compliance with IEC 61131-3 and gives the user countless automation options for the entire tightening process.

Unused slots must be closed off with dummy panels for safety reasons and for reasons of electromagnetic compatibility.

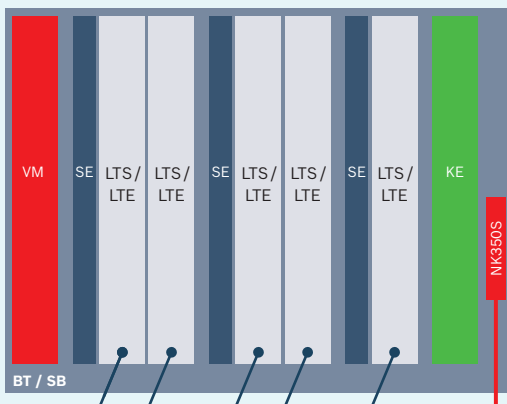

1 CARD RACK/SYSTEM BOX FOR UP TO 5 TIGHTENING CHANNELS AND COMMUNICATION UNIT

BT	Card rack
SB	System box
VM	Power supply module
KE	Communication unit
SE	Control unit
LTS	Servo amplifier for tightening spindles
LTE	Servo amplifier for ErgoSpin hand-held nutrunners
NK	Network coupler

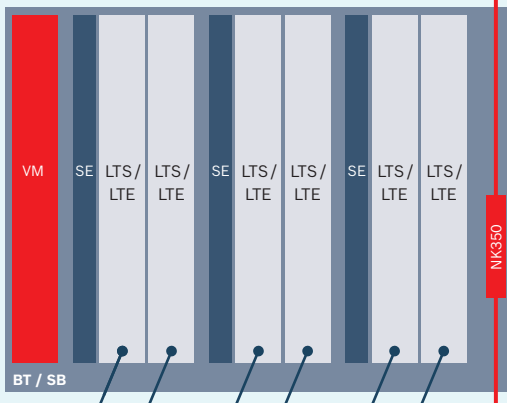

COMBINATION OF MULTIPLE CARD RACKS/SYSTEM BOXES FOR UP TO 40 TIGHTENING CHANNELS

- ▶ Max. 6 tightening channels per BT/SB
- ▶ Max. total length of all network coupling cables: 150 m
- ▶ Max. length of one network coupling cable: 50 m
- ▶ Control of max. 40 tightening channels with one KE350 (up to 16 network couplers)
- ▶ Reliable system bus with diagnostics capabilities
- ▶ Multi-colored LED on network coupler for network status display
- ▶ Type and timing of the incoming signals are processed and supplied to the nearest NK350.

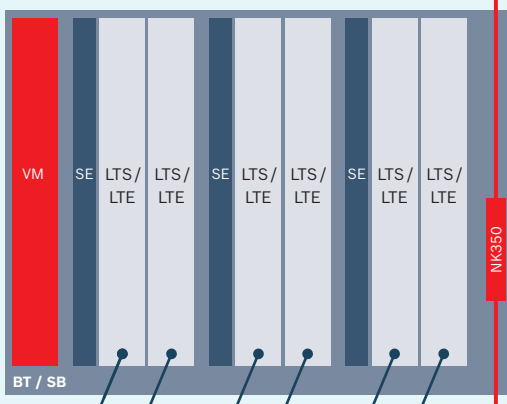

SB356 System Box



- ▶ To accommodate the control and power electronics for up to six tightening channels
- ▶ IP54 protection class

FEATURES

- ▶ Designed for operation without control cabinet
- ▶ For networking of up to 16 BT/SB (with NK350 or NK350S network coupler and NKL network coupler cables)
- ▶ Compact dimensions
- ▶ High packing density
- ▶ Combination of hand-held nutrunner and stationary spindle possible (except CC-ErgoSpin)
- ▶ Fast replacement of control and power components

Code	Dimensions W x H x D mm	Weight (empty) kg	Order no.
SB356	510x600x470	55	0608830251

SB356 system box configuration	Up to 5 channels, 1 x SB356	Up to 40 channels, multiple SB356		Info on page
	SB356 system box	First SB356 system box	Additional SB356 system boxes	
	Number of slots	Number of slots	Number of slots per SB356	
VM 350 power supply module	1	1	1	125
KE350 communication unit	1	1	–	128
SE352/SE352M control unit	3	3	3	126
LTS350D/LTE350D servo amplifier	5	5	6	127
Tightening channels	5	5	6	123/132
NK350S / NK350 network coupler	–	1 x NK350S	1 x NK350	129





DUMMY PANELS

Empty slots are closed off with dummy panels.

Two versions are available: BP351 closes off a KE or LT slot; BP352 simultaneously closes off an SE and an LT slot.



NON-STANDARD LOCKS FOR SB356

Code	Order no.
E1	3608874026
E16	3608874109
 3 mm*	3608874027
 Fiat	3608874028
 Daimler	3608874029
 7 mm	3608874030

* Standard design

Note: You can find the technical data for the Rexroth control electronics in the assembly instruction: www.boschrexroth.com/tightening.

REQUIRED NUMBER OF DUMMY PANELS FOR THE BT356 CARD RACK WITH KE350

Number of channels	BP351 3608878058	BP352 3608878060
1	2	2
2	1	2
3	1	1
4	0	1
5	0	0

BT356 card rack



- ▶ To accommodate the control and power electronics for up to six tightening channels
- ▶ For assembly in the control cabinet or to the mounting plate using mounting brackets

FEATURES

- ▶ For networking of up to 16 BT/SB (with NK350 or NK350S network coupler and NKL network coupler cables)
- ▶ Compact dimensions

Code	Dimensions W x H x D mm	Weight (empty) kg	Order no.
BT356	310x483x381	7	0608830253

BT356 system box configuration	Up to 5 channels 1 x BT356	Up to 40 channels Multiple BT356		Info on page
	BT356 card rack	First BT356 card rack	Additional BT356 card racks	
	Number of slots	Number of slots	Number of slots per BT356	
VM 350 power supply module	1	1	1	122
KE350 communication unit	1	1	–	122
SE352/SE352M control unit	3	3	3	122
LTS350D/LTE350D servo amplifier	5	5	6	122
Tightening channels	5	5	6	122/132
NK350S / NK350 network coupler	–	1 x NK350S	1 x NK350	122

Note: You can find the technical data for the Rexroth control electronics in the assembly instruction: www.boschrexroth.com/tightening.

Permissible configuration with BT356/SB356 Servo amplifiers

PLANNING ASSISTANCE: SYSTEM BOX AND CARD RACK CONFIGURATION

One tightening channel consists of the following components:

- ▶ ErgoSpin hand-held nutrunner or tightening spindle
- ▶ Connection cable
- ▶ Control unit
- ▶ Servo amplifier

The KE350 or KE350G IL communication unit is responsible for internal and external system communication. If the appropriate control and power electronics are installed, both stationary tightening spindles and ErgoSpin hand-held nutrunners can be connected to and operated on the SB356 system box and the BT356 card rack. Mixed operation of stationary tightening spindles and ErgoSpin hand-held nutrunners on a system box or a card rack is possible at any time.

Not every configuration is permitted due to the fact that the power consumption of the servo amplifier depends on the type of tightening spindle or ErgoSpin hand-held nutrunner that is connected. The maximum permissible peak current for up to six tightening channels in the card rack or system box is 140 A. This is why you may only install components with a power consumption that does not exceed a total of 140 A.

TOTAL POWER CONSUMPTION ≤ 140 A (TIGHTENING SPINDLES + ERGOSPIN)

- ▶ Up to 40 tightening channels by combining multiple card racks/system boxes
- ▶ Maximum system reliability thanks to 100% digital data transfer
- ▶ Integrated system for hand-held nutrunners and stationary technology
- ▶ Scalable and open for extensions

Max. power consumption Ampere	Stationary tightening spindles				ErgoSpin hand-held nutrunners			
	45 A	28 A	14 A	7 A	50 A	33 A	18 A	11 A
Tightening spindle or ErgoSpin hand-held nutrunner	LTS350D servo amplifier + Tightening spindle size 5	LTS350D servo amplifier + Tightening spindle size 4	LTS350D servo amplifier + Tightening spindle size 3	LTS350D servo amplifier + Tightening spindle size 2	LTE 350D servo amplifier + ErgoSpin hand-held nutrunners ESA100S ESA150S ESA220S ESV073 ESV146	LTE 350D servo amplifier + ErgoSpin hand-held nutrunners ESA040... ESA056... ESA065... ESA075... ESM025... ESM035... ESV025 ESV050	LTE 350D servo amplifier + ErgoSpin hand-held nutrunners ESA030...	LTE 350D servo amplifier + ErgoSpin hand-held nutrunners ESA013... ESM012QD ESV005 ESV012

EXAMPLE: WHEEL BOLTS



In this example, five wheel bolts on each side of the vehicle are tightened to 130 Nm using size 4 tightening spindles.

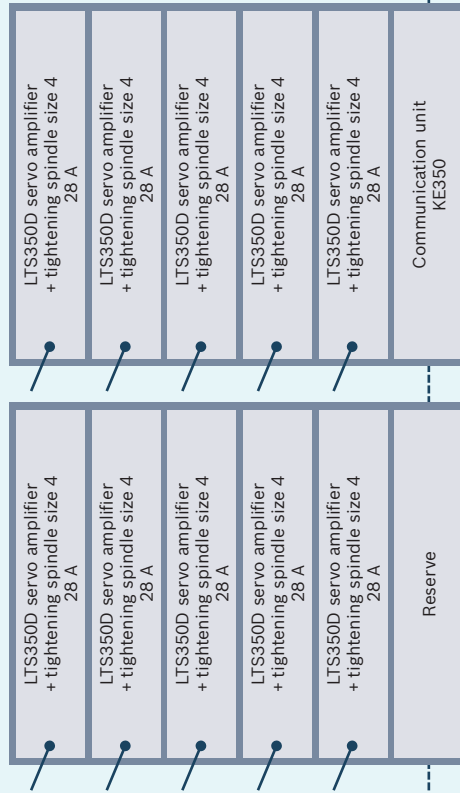

Ethernet connection

BT/SB power consumption
 $5 \times 28 \text{ A} = 140 \text{ A} (\leq 140 \text{ A})$

Up to 5 tightening spindles can be operated on the first system box/first card rack.

Networking with network coupler

System boxes and card racks can be connected using network couplers.

EXAMPLE: MOTOR CONNECTION



In this example, the camshaft bearing cap and the cylinder head are each tightened to the motor with double nutrunners (size 3 and 4 tightening spindles) with 15 Nm and 130 Nm respectively. In addition, small parts are tightened with rightangle and pistolgrip nutrunners.

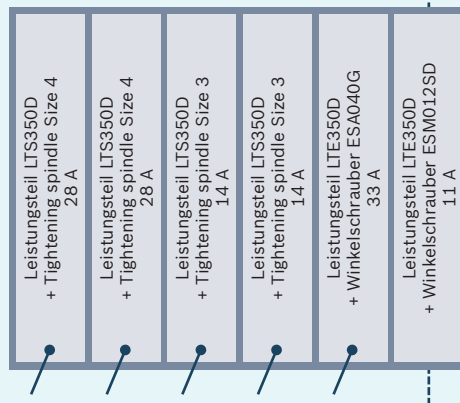

Networking with network coupler

BT/SB power consumption
 $2 \times 28 \text{ A} + 2 \times 14 \text{ A} + 33 \text{ A} + 11 \text{ A} = 128 \text{ A}$
 $(\leq 140 \text{ A})$

Mixed operation with up to six tightening channels is possible on an SB356 system box or a BT356 card rack.

VM350 power supply module



- ▶ Used to supply power to all the slots in the BT356 card rack or in the SB356 system box.

Code	Order no.
VM350	0 608 750 110

FEATURES

- ▶ One VM350 is required for each card rack or system box.
- ▶ 24 V interface (X1S1) on the front to ensure external power supply of the KE, SE, and LT in event of power failure or if the supply is switched off
- ▶ Integrated E-stop functionality (performance level d)
- ▶ 24 V power supply for external consumers

SE352 and SE352M control units



- ▶ To control and monitor the tightening process of up to two independent tightening channels per control unit
- ▶ For hand-held nutrunners and stationary spindles

Code	Order no.
SE352	0 608 830 262
SE352M	0 608 830 263



Example layout
SE352M with IM24V

FEATURES

- ▶ Carries out system diagnosis and monitors all individual components of a tightening channel
- ▶ Tightening processes and rework strategies are simply and flexibly programmed via the BS350 operating system.
- ▶ Automatic recognition of individual components enables fast and secure start-up.
- ▶ The SE352M control unit is equipped with one free slot (on delivery, the SE352M control unit slot is sealed with a cover). An IM24V interface module can be inserted in this slot for communication with superior controllers.
- ▶ USB port interface used for the insertion of the license stick for the angle compensation functionality.

Servo amplifiers for tightening spindles and ErgoSpin hand-held nutrunners



- ▶ For EC motor control
- ▶ Integrated motor contactor

Code		Order no.
LTS350D	For all tightening spindles	0 608 750 125
LTE350D	For all ErgoSpin hand-held nutrunners	0 608 750 126

FEATURES

- ▶ The control parameters are transmitted digitally from the SE control unit to the LT servo amplifier
- ▶ LC display for tightening results and system information
- ▶ Integrated E-stop functionality (performance level d)

KE350 and KE350G IL communication units



- ▶ To coordinate individual control units and organize the interfaces with external systems (e.g. PLC or central computer)

Code	Order no.
KE350	0 608 830 264
KE350G IL	0 608 830 265

FEATURES

- ▶ System-internal communication with the control units occurs via a standard bus system
- ▶ One serial interface and three free slots for connecting to external systems
- ▶ Various interface modules are available for controlling and data communication
- ▶ On delivery, the slots in the KE350 and KE350G IL communication units are closed off with covers
- ▶ Integrated logics in KE350G IL: flexible programming in compliance with IEC 61131 3, enables countless automation options for the entire tightening process

Accessories for control and power electronics



NETWORK COUPLER

Code	Order no.
NK350	3 608 877 367
NK350S*	3 608 877 368

*with integrated 24V power supply for the system bus



DUMMY PANELS

Code	Order no.
BP351	3 608 878 058
BP352	3 608 878 060



MOUNTING BRACKET SET FOR BT356

Code	Order no.
BTW356	3608878116



MASS STORAGE

Code	Memory size	Order no.
CS350 1G	1 GB	0608830318

Control cabinets



Ask us – we would be happy to advise you! With the BT356 card rack, the Rexroth modular system is ideally equipped for use in control cabinets. Benefit from our experience: we can offer you advice on which control cabinet is best suited to your production environment and how control and power electronics can be integrated easily.

We provide control cabinets manufactured to your requirements as well as control cabinets in the following standard dimensions:

- ▶ 1,800x600x500 mm (H x W x D) for up to 18 tightening channels or 17 tightening channels plus KE350 / KE350G IL for tightening spindles in sizes 2, 3, and 4 (size 5 and mixed configurations available on request)
- ▶ 2,000x600x500 mm (H x W x D) for up to 24 tightening channels or 23 tightening channels plus KE350 / KE350G IL for tightening spindles in sizes 2 and 3 (sizes 4 and 5 and mixed configurations available on request)

The standard delivery color is RAL 7032. Other options, e.g. other colors, are available on request.

CONTROL CABINETS

On request



RACK FOR 2 SYSTEM BOXES

On request



Open and flexible: Interface modules

The interface modules are the connection between the tightening systems and the process controls. Today, Rexroth offers customers all common standards of fieldbuses such as PROFIBUS and DeviceNet as well as Ethernet-based fieldbus systems.



- ▶ Perfect network connection
- ▶ Connection between the tightening system, and the company's IT
- ▶ All standard fieldbuses
- ▶ Open, modular system concept for future standards

CS351**1**

X6C1 slot for CF350
1GB mass storage

2

Two slots (B1, B2)
for 24V I/O interface
modules

3

Slot A for fieldbus
modules

4

Ethernet on board





**KE350 / KE350G IL****1****2****3****4**





To ensure that the tightening system optimally matches your control environment today and in the future, free slots for interface modules are included on the CS351 Compact System, the KE350, and the KE350G IL.

On delivery, the slots are closed off with covers.

CS351...-D and KE350G IL have an additional DVI interface to connect an external monitor and a corresponding USB feedback channel.

Interface modules

	Slot	Fieldbus / designation	Code	Order no.	Description
	A	PROFIBUS DP	IMpdp	0 608 830 266	<ul style="list-style-type: none"> ▶ Data transfer via I/O level, e.g. for PLC functionality ▶ Insertion in the A slot of the KE350... or the CS351... ▶ Occupies a 400 byte address space on the fieldbus, which can be adjusted from 16I/16O points (2 bytes) to 512 I/512O points (128 bytes), as well as 0-64 bytes ID code and 0-242 bytes data ▶ The logical assignment of the control signals is set using the BS350 operating system
	A	DeviceNet	IMdev	0 608 830 267	<ul style="list-style-type: none"> ▶ Data transfer via I/O level, e.g. for PLC functionality ▶ Insertion in the A slot of the KE350... or the CS351... ▶ Occupies a 512 byte address space on the fieldbus, which can be adjusted from 16 I/16O points (4 bytes) to 512 I/512O points (128 bytes), as well as a 0-64 bytes ID code ▶ The logical assignment of the control signals is set using the BS350 operating system
	A	PROFINET IO	IMpnio	0 608 830 272	<ul style="list-style-type: none"> ▶ Complete PROFINET IO interface with IO device function (slave) ▶ Simple data transfer via I/O level ▶ Complies with the real-time classification (RT) of the PROFIBUS user organization
	A	PROFINET IO	IMpnio2	0 608 830 312	<ul style="list-style-type: none"> ▶ Complete PROFINET IO interface with IO device function (slave) ▶ Simple data transfer via I/O level ▶ Complies with the real-time classification (RT) of the PROFIBUS user organization ▶ KE: from 2 to 64 byte I/O, to 254 byte E-data, to 254 byte output data ▶ CS: from 2 to 8 byte I/O, to 64 Byte E-data, to 254 Byte output data ▶ Configurable into byte and multiple byte blocks ▶ Integrated switch for building networks in star, line or ring topology

	Slot	Fieldbus/ designation	Code	Order no.	Description
	A	EtherCat	IMecat	0 608 830 302	<ul style="list-style-type: none"> ▶ Enables coupling of the tightening system (slave) to EtherCat networks ▶ Data transfer possible via I/O level ▶ integrated switch for building networks in star, line or ring topology
	A	Ethernet/IP	IMenip	0 608 830 271	<ul style="list-style-type: none"> ▶ Complete Ethernet/IP interface with adapter function (slave), includes all analog and digital components of a powerful Ethernet / IP connection ▶ Simple data transfer via I/O level ▶ Certified module tested for interoperability with leading Ethernet/IP scanner modules
	A	Ethernet/IP	IMenip2	0 608 830 313	<ul style="list-style-type: none"> ▶ Simple data transfer via I/O level ▶ Support for transfer rates of 10 Mbps or 100 Mbps ▶ The interface is designed as an 8-pin RJ45 socket ▶ Use of connector according to IEC 61158 ▶ Integrated switch for building networks in star, line or ring topology ▶ the LED NS shows status of the Ethernet ▶ Power is supplied directly through components of System 350
	A	Modbus TCP	IMmtcp	0 608 830 273	<ul style="list-style-type: none"> ▶ Complete ModbusTCP interface with server function (slave) ▶ Includes all analog and digital components of a powerful ModbusTCP interface connection ▶ Simple data transfer via I/O level
	B	24V I/O interface	IM24V	0 608 830 259	<ul style="list-style-type: none"> ▶ Enables control over the tightening system and output of 24 V status signals via a 24 V interface ▶ Insertion in a corresponding slot on the KE350 or KE350G IL or the SE352M control unit ▶ Provides 10 inputs and 13 outputs. The outputs are short circuit-proof and protected against reverse polarity ▶ Complies with DIN 19240

Rexroth cables: consistent, digital data transfer

Precise control and consistently reliable measurements for checking tightening results are the outstanding features of tightening systems from Rexroth. This level of precision requires data transport that is always error-free. This is why the tightening systems from Rexroth are equipped with fully digital data communication.

- ▶ Secure and reliable data transfer thanks to digital technology
- ▶ Maximum cable length of up to 100 meters enables flexible hall design
- ▶ Connection cables for tightening spindles are suitable for robot use
- ▶ Customer-specific cable lengths available





- ▶ Connection cables for joining tightening spindles with compact or modular systems
- ▶ Connection cables for joining hand-held nutrunners with compact or modular systems
- ▶ Extension cables for extending connection cables of tightening spindles with compact and modular systems
- ▶ Network coupler cables for connecting multiple modular systems
- ▶ Measurement transducer cables for connecting individual components of a tightening spindle
- ▶ USB programming cable for connecting a PC with compact or modular systems
- ▶ Mains connection cables for joining compact systems with a power socket (included in the scope of delivery in Europe)



Cables for tightening spindles with molded connectors

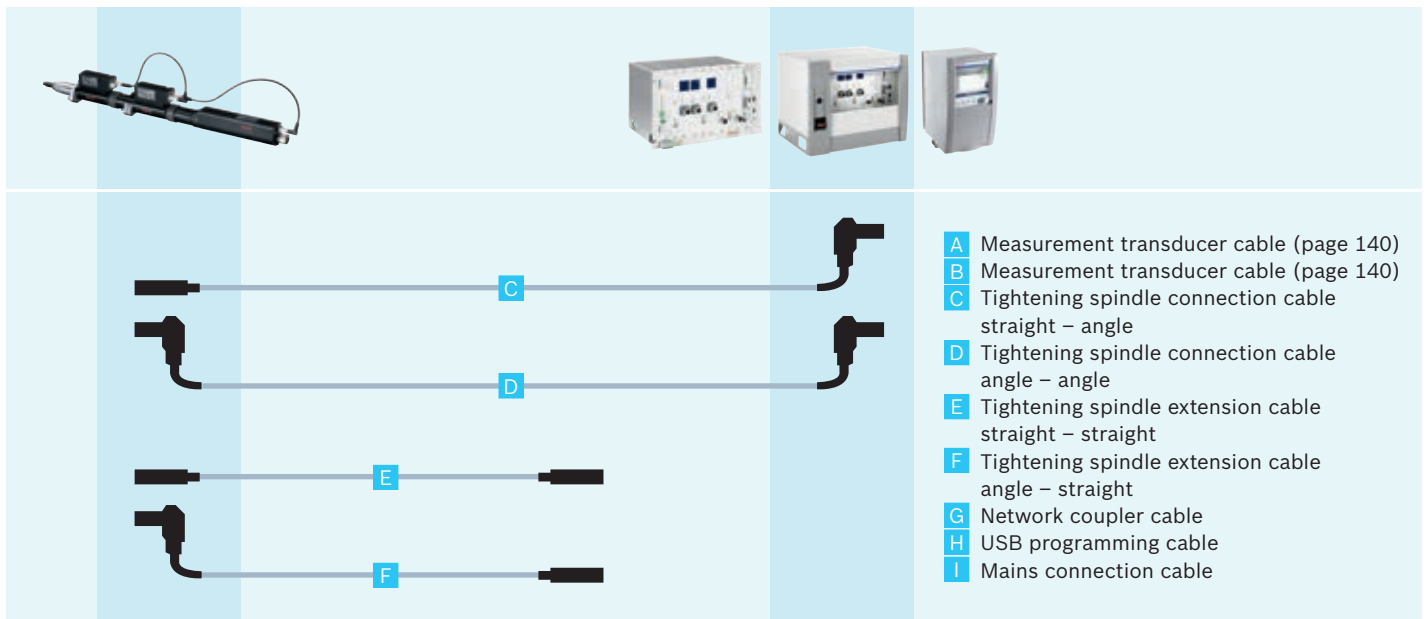

TIGHTENING SPINDLE CONNECTION CABLE

The tightening spindle is connected to the CS351S... Compact System or the LTS350D servo amplifier via a connection cable. Up to 5 extension cables may be connected to the connection cable one after the other in any order. For applications where the tightening spindle is in constant motion, we recommend constructing the connection from several individual parts.

Max. length of the connection cable:

- ▶ When connecting to a system box or card rack: 100 m
- ▶ When connecting to a Compact System: 50 m

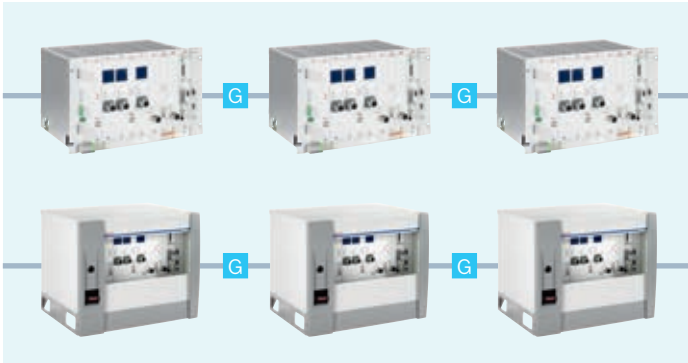

CONNECTING CARD RACKS AND SYSTEM BOXES

The network coupler cables connect individual BT356 card racks and SB356 system boxes. A combination of card racks and system boxes is also possible. The length of the network coupler cable between the individual card racks / system boxes can be as much as 50 m. The total length of all network coupler cables may not exceed 150 m. Network coupler cables are not extendable.

NOTE

To ensure function and system reliability at all times, only use the cables listed here. The connection cables for tightening spindles are suitable for robot use.

	Code	Order no.	Length m	Weight kg
C	S-003-S-A	0608 740 100	3	1.015
	S-005-S-A	0608 740 101	5	1.495
	S-007-S-A	0608 740 102	7	1.975
	S-010-S-A	0608 740 103	10	2.695
	S-015-S-A	0608 740 104	15	3.895
	S-020-S-A	0608 740 105	20	5.095
	S-FREE-S-A*	0608 741 100	>0.5	-
	D	S-003-A-A	0608 740 110	3
S-005-A-A		0608 740 111	5	1.540
S-007-A-A		0608 740 112	7	2.020
S-010-A-A		0608 740 113	10	2.740
S-015-A-A		0608 740 114	15	3.940
S-FREE-A-A*		0608 741 110	>0.5	-
E		S-EXT-003-S-S	0608 740 120	3
	S-EXT-005-S-S	0608 740 121	5	1.450
	S-EXT-007-S-S	0608 740 122	7	1.930
	S-EXT-010-S-S	0608 740 123	10	2.650
	S-EXT-015-S-S	0608 740 124	15	3.850
	S-EXT-020-S-S	0608 740 125	20	5.050
	S-EXT-FREE-S-S*	0608 741 120	>0.5	-
	F	S-EXT-003-A-S	0608 740 130	3
S-EXT-005-A-S		0608 740 131	5	1.495
S-EXT-007-A-S		0608 740 132	7	1.975
S-EXT-010-A-S		0608 740 133	10	2.695
S-EXT-FREE-A-S*		0608 741 130	>0.5	-

	Code	Order no.	Length m	Weight kg
G	NKL0.6	3 608 877 369	0.6	-
	NKL002	3 608 877 370	2	-
	NKL003	3 608 879 240	3	-
	NKL005	3 608 877 371	5	-
	NKL010	3 608 877 372	10	-
	NKLF*	3 608 877 373 / ...	>0.5	-
	H	USB350	3 608 877 427	3
I		CS351USC (110V)**	3 608 877 033	1.8

* The connection cables S-FREE-S-A [C], S-FREE-A-A [D] as well as extension cables S-EXT-FREE-S-S [E], S-EXT-FREE-A-S [F] and the network coupler cable NKLF [G] require a length specification in addition to the part number. The "FREE" in the code stands for flexible cable lengths in 0.25-m increments. The length and order number must both be indicated on your order.

Ordering example: Connection cable [C] 17.75 m long is S-FREE-S-A 0 608 741 100 /17.75

Calculation of the weight for free lengths:

Weight of cable: 240 g/m
Weight angle plug: 170 g
Weight straight plug: 125 g

** Mains connection cable USA (The mains connection cable is included in the standard scope of delivery for Europe.)

Measurement transducer cables



TIGHTENING SPINDLE WITH SPINDLE BEARING, OFFSET OUTPUT DRIVE, OR ANGLE HEAD

Size	A	Code	Order no.
2		MC038	0 608 730 100
3		MC038	0 608 730 100
4		MC046	0 608 730 101
5		MC061	0 608 730 103
5	With blocking adapter	MC072	0 608 730 104

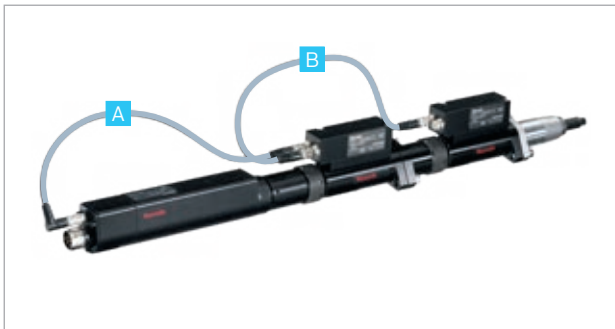

TIGHTENING SPINDLE WITH SPINDLE BEARING, OFFSET OUTPUT DRIVE OR ANGLE HEAD AND REDUNDANT MEASUREMENT TRANSDUCER

Size	A	Code	Order no.	B	Code	Order no.
2		MC038	0 608 730 100		MCR033	0 608 730 200
3		MC038	0 608 730 100		MCR033	0 608 730 200
4		MC046	0 608 730 101		MCR033	0 608 730 200
5		MC061	0 608 730 103		MCR040	0 608 730 201



TIGHTENING SPINDLE WITH OFFSET OUTPUT DRIVE WITH INTEGRATED MEASUREMENT TRANSDUCER

Size	VMC	A	Code	Order no.
3	3VMC0..		MC046	0 608 730 101
4	4VMC150		MC055	0 608 730 102
4	4VMC210		MC055	0 608 730 102
4	4VMC360		MC061	0 608 730 103

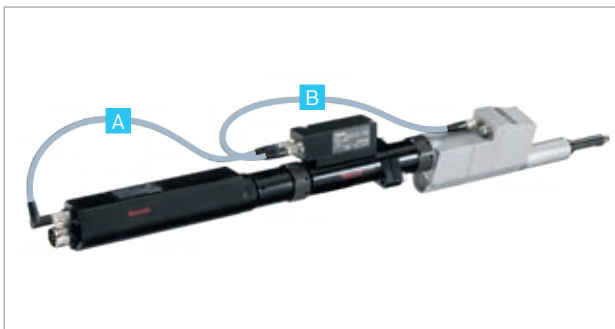

TIGHTENING SPINDLE WITH OFFSET OUTPUT DRIVE WITH INTEGRATED MEASUREMENT TRANSDUCER AND REDUNDANT MEASUREMENT TRANSDUCER

Size	VMC	A	Code	Order no.	B	Code	Order no.
3	3VMC0..		MC038	0 608 730 100		MCR045	0 608 730 202
4	4VMC150		MC046	0 608 730 101		MCR040	0 608 730 201
4	4VMC210		MC046	0 608 730 101		MCR040	0 608 730 201
4	4VMC360		MC046	0 608 730 101		MCR045	0 608 730 202

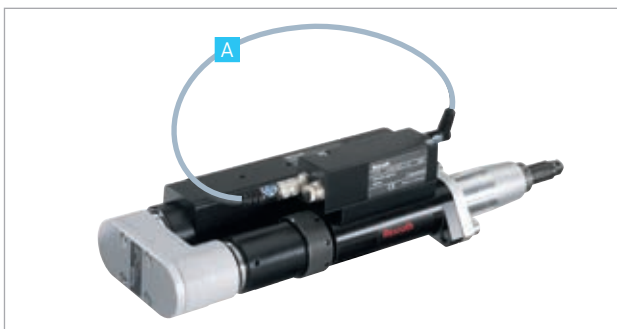

TIGHTENING SPINDLE WITH TRANSVERSE GEARBOX

Size	A	Code	Order no.
2		MC046	0 608 730 101
3		MC046	0 608 730 101
4		MC046	0 608 730 101
5		MC061	0 608 730 103

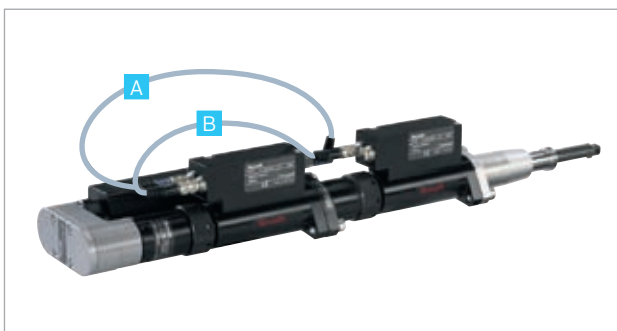

TIGHTENING SPINDLE WITH TRANSVERSE GEARBOX AND REDUNDANT MEASUREMENT TRANSDUCER

Size	A	Code	Order no.	B	Code	Order no.
2		MC046	0 608 730 101		MCR033	0 608 730 200
3		MC046	0 608 730 101		MCR033	0 608 730 200
4		MC046	0 608 730 101		MCR033	0 608 730 200
5		MC061	0 608 730 103		MCR040	0 608 730 201

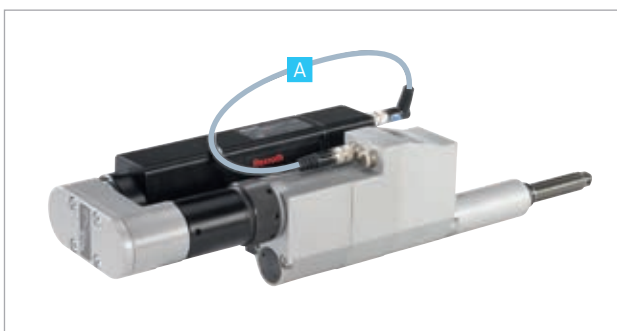

TIGHTENING SPINDLE WITH OFFSET OUTPUT DRIVE WITH INTEGRATED MEASUREMENT TRANSDUCER AND TRANSVERSE GEARBOX

Size	VMC	A	Code	Order no.
3	3VMC0..		MC038	0 608 730 100
4	4VMC150		MC038	0 608 730 100
4	4VMC210		MC038	0 608 730 100
4	4VMC360		MC038	0 608 730 100

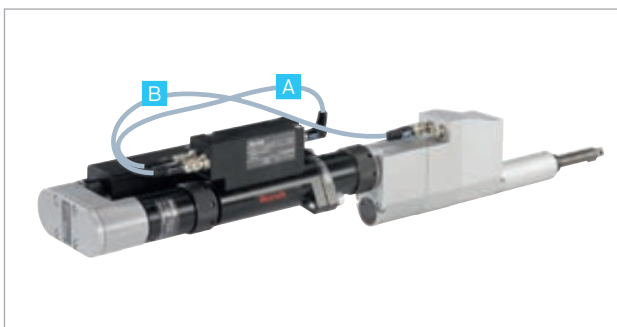

TIGHTENING SPINDLE WITH OFFSET OUTPUT DRIVE WITH INTEGRATED MEASUREMENT TRANSDUCER AND TRANSVERSE GEARBOX AND REDUNDANT MEASUREMENT TRANSDUCER

Size	VMC	A	Code	Order no.	B	Code	Order no.
3	3VMC0..		MC038	0 608 730 100		MCR045	0 608 730 202
4	4VMC150		MC038	0 608 730 100		MCR040	0 608 730 201
4	4VMC210		MC038	0 608 730 100		MCR040	0 608 730 201
4	4VMC360		MC038	0 608 730 100		MCR045	0 608 730 202

Cables for ErgoSpin hand-held nutrunners with molded connectors

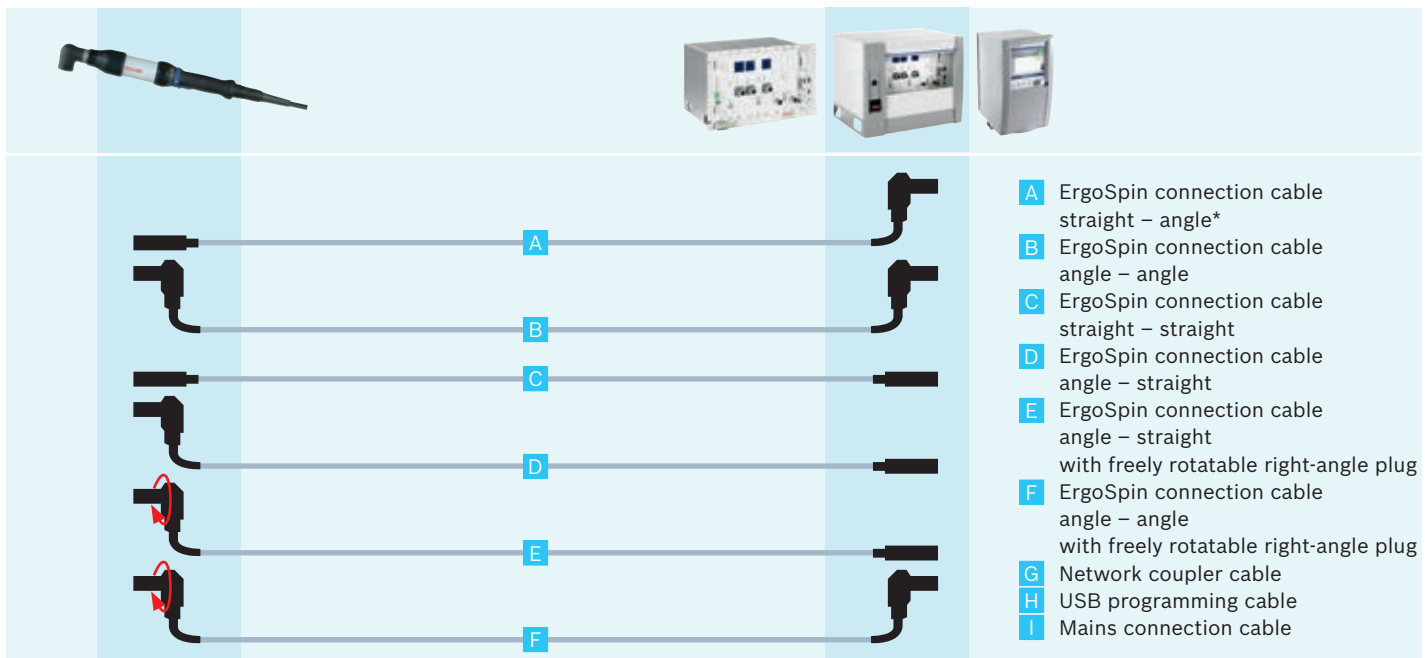
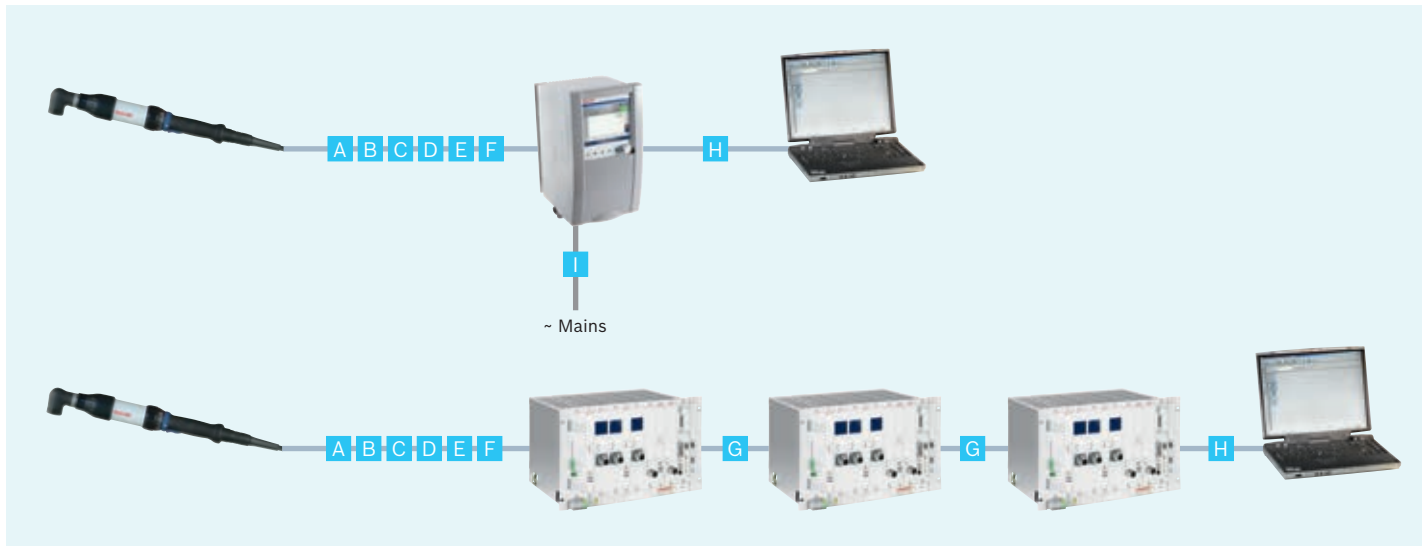

* Connection cable S-A with extra-long bend relief on request

ERGOSPIN CONNECTION CABLE

The ErgoSpin hand-held nutrunner is connected to the CS351E... Compact System or the LTE350D servo amplifier via a connection cable. Up to 5 of the connection cables listed at the side may be connected one after the other in any order. For applications where the hand-held nutrunner is in constant motion, we recommend constructing the connection from several individual parts.

- Max. length of the connection cable:
- ▶ When connecting to a system box or card rack: 100 m
 - ▶ When connecting to a Compact System: 50 m



CONNECTING CARD RACKS AND SYSTEM BOXES

The network coupler cables connect individual BT356 card racks and SB356 system boxes. A combination of card racks and system boxes is also possible. The length of the network coupler cable between the individual card racks / system boxes can be as much as 50 m. The total length of all network coupler cables may not exceed 150 m. Network coupler cables are not extendable.

NOTE

To ensure function and system reliability at all times, only use the cables listed here. The ErgoSpin connection cables are suitable for robot use.

	Code	Order no.	Length m	Weight kg
A	E-003-S-A	0608 740 200	3	1.015
	E-005-S-A	0608 740 201	5	1.495
	E-007-S-A	0608 740 202	7	1.975
	E-010-S-A	0608 740 203	10	2.695
	E-015-S-A	0608 740 204	15	3.895
	E-020-S-A	0608 740 205	20	5.095
	E-FREE-S-A*	0608 741 200	>0.5	-
B	E-003-A-A	0608 740 210	3	1.06
	E-005-A-A	0608 740 211	5	1.54
	E-007-A-A	0608 740 212	7	2.02
	E-010-A-A	0608 740 213	10	2.74
	E-FREE-A-A*	0608 741 210	>0.5	-
C	E-003-S-S	0608 740 220	3	0.97
	E-005-S-S	0608 740 221	5	1.45
	E-007-S-S	0608 740 222	7	1.93
	E-010-S-S	0608 740 223	10	2.65
	E-FREE-S-S*	0608 741 220	>0.5	-
D	E-003-A-S	0608 740 230	3	1.015
	E-005-A-S	0608 740 231	5	1.495
	E-007-A-S	0608 740 232	7	1.975
	E-010-A-S	0608 740 233	10	2.695
	E-FREE-A-S*	0608 741 230	>0.5	-
E	E-003-ROT-A-S	0608 740 240	3	1.07
	E-005-ROT-A-S	0608 740 241	5	1.55
	E-007-ROT-A-S	0608 740 242	7	2.03
	E-010-ROT-A-S	0608 740 243	10	2.75
	E-FREE-ROT-A-S*	0608 741 240	>0.5	-

	Code	Order no.	Length m	Weight kg
F	E-003-ROT-A-A	0608 740 250	3	1.115
	E-005-ROT-A-A	0608 740 251	5	1.595
	E-007-ROT-A-A	0608 740 252	7	2.075
	E-010-ROT-A-A	0608 740 253	10	2.795
	E-FREE-ROT-A-A*	0608 741 250	>0.5	-
G	NKL0.6	3608 877 369	0.6	-
	NKL002	3608 877 370	2	-
	NKL003	3608 879 240	3	-
	NKL005	3608 877 371	5	-
	NKL010	3608 877 372	10	-
	NKLF*	3608 877 373 / ...	>0.5	-
H	USB350	3608 877 427	3	-
I	CS351USC (110V)**	3608 877 033	1.8	-

* The connection cables E-FREE-S-A [A], E-FREE-A-A [B], E-FREE-S-S [C], E-FREE-A-S [D], E-FREE-ROT-A-S [E], E-FREE-ROT-A-A [F] and NKLF [G] require a length specification in addition to the part number. The "FREE" in the code stands for flexible cable lengths in 0.25-m increments. The length and order number must both be indicated on your order.

Ordering example: Connection cable [A] 17.75 m long is
E-FREE-S-A 0 608 741 200 / 17.75

Calculation of the weight for free lengths:

Weight of cable: 240 g/m
Weight angle plug: 170 g
Weight freely rotatable angle plug: 225 g
Weight straight plug: 125 g

** Mains connection cable USA (The mains connection cable is included in the standard scope of delivery for Europe.)

The complete package: software and operating system

Easy configuration, parameterization and analysis: with the PC via the network or with the laptop on-site. This provides a flexible working environment and allows you to generate tightening programs as well as analyze tightening cases and conduct system tests. The user interface enables intuitive operation.



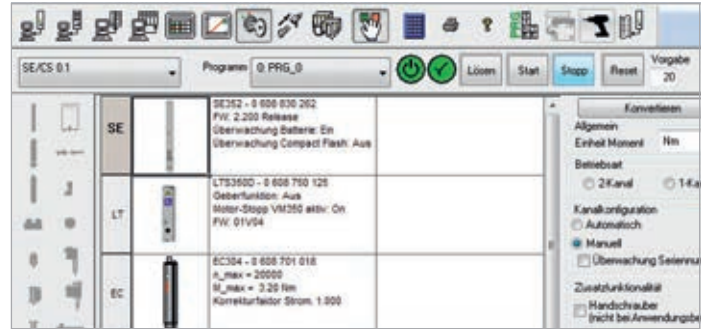

- ▶ Fast commissioning thanks to intuitive menu design
- ▶ Time-saving and mix-up-proof thanks to automatic detection of electronic components
- ▶ Simple entry of tightening process parameters
- ▶ Comprehensive selection of target and monitoring functions for adaptation to the individual tightening case
- ▶ Evaluation options using graphs and statistics for process optimization

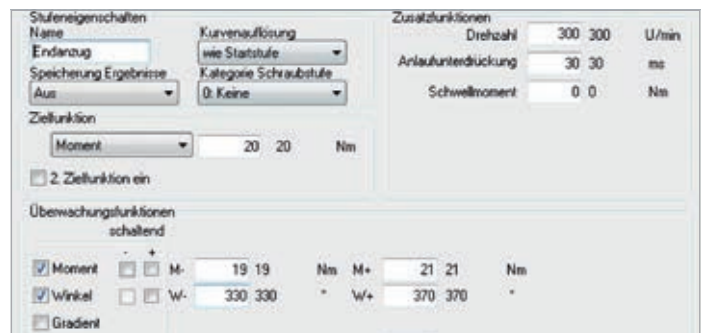

CONFIGURATION AND PROGRAMMING

- ▶ Programming via convenient, icon-supported tools
- ▶ Configuration of tightening processes on the graphic interface
- ▶ Target and monitoring parameters are easily entered in the preset windows

ANALYSIS

- ▶ Tightening graph for performing a quick tightening case analysis
- ▶ Good range with clear display of the state of the tightening results in the target window
- ▶ Histogram provides a quick overview of the statistical distribution of the tightening results

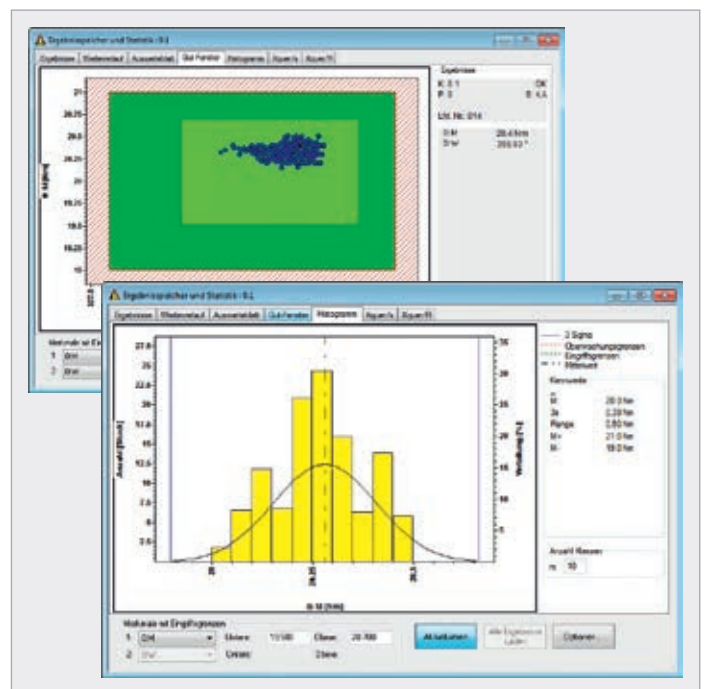
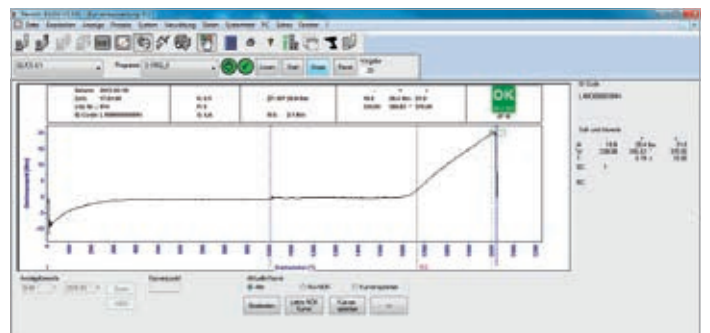

BS350 operating system

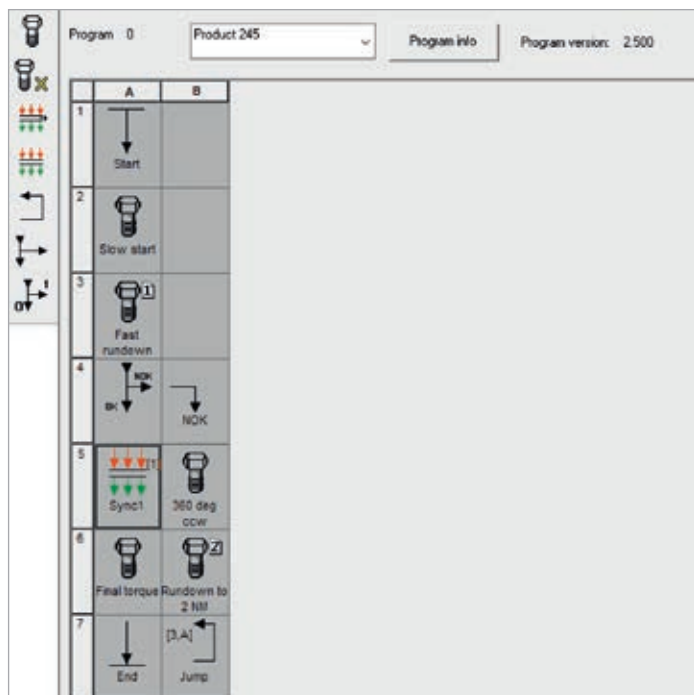

INTUITIVE, RELIABLE TIGHTENING PROCESSES

System installation and programming of individual tightening tasks is done via convenient, icon-supported tools. Tightening processes are configured on the graphic interface.

- Software for actuation, programming and monitoring of tightening processes



SYSTEM REQUIREMENTS

- BS350 V2.600: Windows 7 and Windows 10
- Connection to tightening system: via USB or Ethernet.

NOTE

Rexroth is constantly adapting its products to meet the latest technological standards and thus retains the right to change its software and firmware. Find out about the latest software as well as software and firmware updates on the Internet at www.boschrexroth.com/tightening.



You can easily enter target and monitoring parameters in the preset windows.

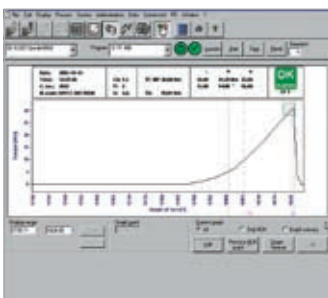

Graph

The tightening graph helps you quickly analyze tightening cases.

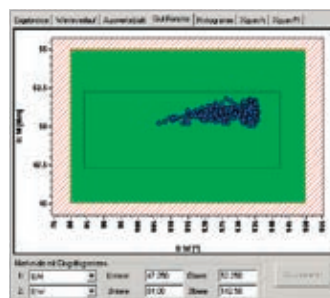

Good range window

The good range window clearly shows you the location of tightening results in the target window.

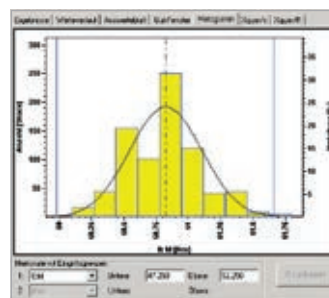

Histogram

The histogram gives you a quick overview of the statistical distribution of the tightening results.

The results window displays a table with multiple columns including 'No.', 'Result', 'Code', 'Date', 'U', 'Program', and 'R'. The rows are color-coded in green and orange, representing different categories of results.

Results window

Internal results memory of up to 40,000 tightening results and filter search functionality.

Code	License	Order no.	Language versions*
BS350 V2.600 1	1 x license	0 608 830 315	de/fr/it/en/es/pt/
BS350 V2.600 2	10 x license	0 608 830 316	cs/hu/sk/pl/ru/zh
BS350 V2.600 3	Plant license	0 608 830 317	

* Language versions

de = German
fr = French
it = Italian

en = (US-)English
es = Spanish
pt = Portuguese

cs = Czech
hu = Hungarian
sk = Slovakian

pl = Polish
ru = Russian
zh = Simplified Chinese

IndraWorks – the tool for all engineering tasks

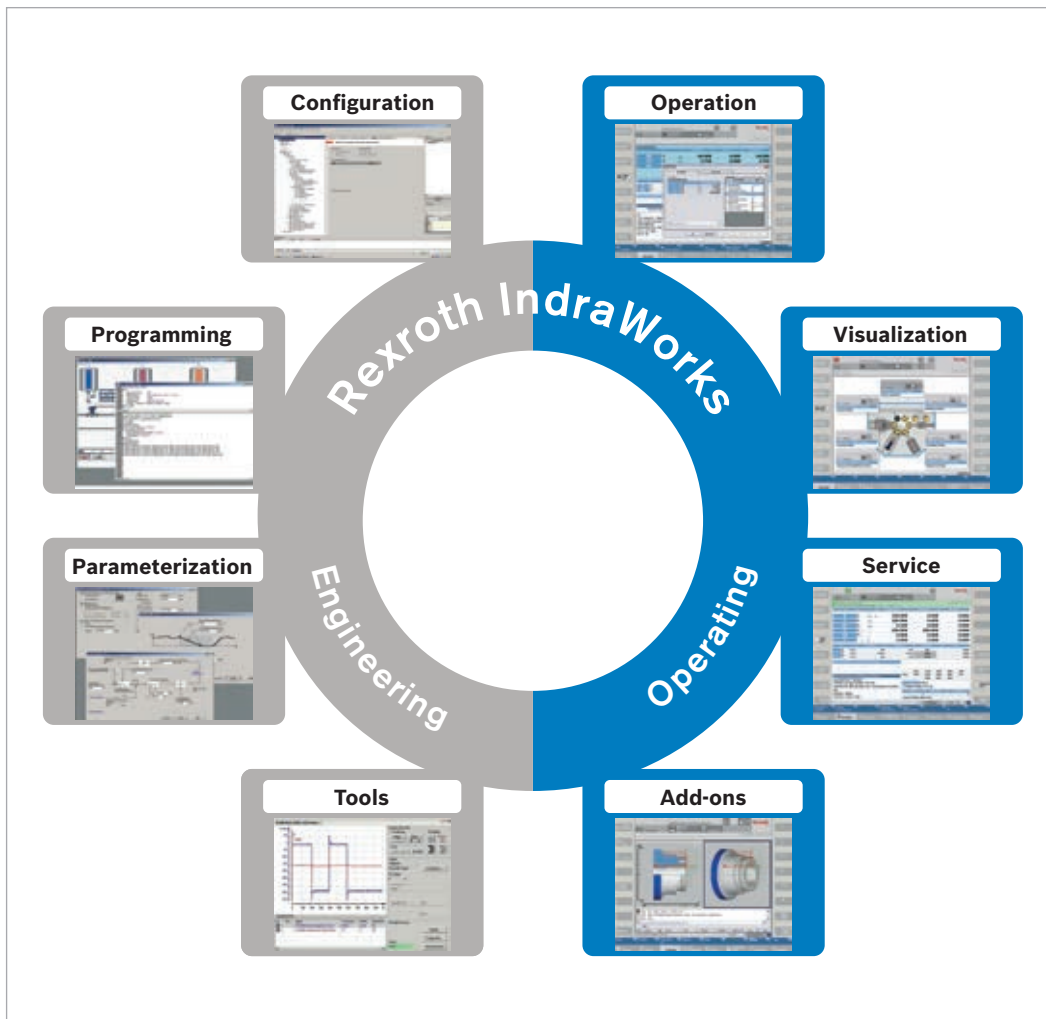

- ▶ Engineering framework for all Rexroth automation systems
- ▶ The tool for all engineering tasks

FEATURES

- ▶ Available for all systems and solutions from Rexroth
- ▶ Integrated framework for all engineering tasks
- ▶ Consistent operating environment for project planning, programming, visualization, and diagnostics
- ▶ Central project management with intuitive system navigation
- ▶ Intelligent operation with wizard support
- ▶ Comprehensive online help
- ▶ Uniform programming according to the PLC standard IEC 61131-3
- ▶ PLCopen-conform function block and technology libraries
- ▶ Standardized interfaces for communication
- ▶ Transparent access to all system components
- ▶ Integrated FDT/DTM interface for integration of the DTM of third-party manufacturers

Rexroth IndraWorks allows you to solve all tasks in a uniform and intuitive software environment – from project planning and programming to visualization and diagnostics.

The uniform engineering framework IndraWorks is consistently available for all systems from Rexroth. You, as user, profit from fast and transparent access to all functions and system data of the automation components.

The standardized tools and interfaces help you to solve all engineering tasks centrally with a single software.

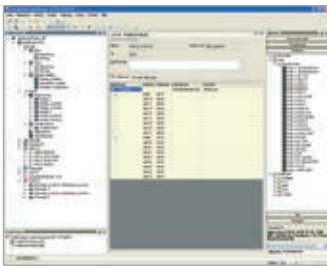

Project development

The overall system is uniformly and consistently projected for all solutions. User and multi-project management are available in all instances. The project and device explorers provide access to all system components. With its clearly organized dialog boxes, IndraWorks guides you intuitively through the configuration of your system.



Programming

The IndraLogic runtime system that is integrated in all solutions is consistently programmed in IndraWorks. The complete language scope specified in IEC 61131-3 is available. System-specific additional functions, such as motion blocks according to PLCopen or technology blocks, can be quickly and transparently implemented in your logic programs.

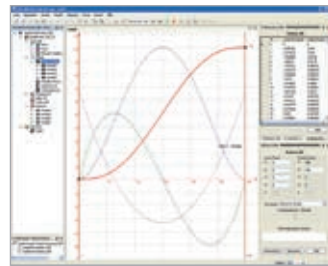

Tools

The tools for all engineering tasks are integrated in IndraWorks. Additional solution-specific tools are consistently available in the software framework.

You can find information on IndraWorks for the 350 Tightening System in the Internet at www.boschrexroth.com/tightening

Description	Type key	Order no.
IndraWorks for 350 Tightening System	SWA-IWORKS-ML*-12VRS-D0-DVD**	R 911 334 632

Operator Guidance System

For complex manual tightening tasks in the automotive industry, special attention needs to be paid to process reliability. The Operator Guidance System allows you to support your employees as best as possible in the assembly of products with many variants.



The virtual guidance system supports the employee through the individual work steps with step-by-step instructions on a screen. It ensures that the correct components and tools are used for each process and the parts are assembled correctly. Production errors are avoided in this way and the quality is improved significantly. Manufacturers can increase the process reliability and productivity of their productions using the Operator Guidance System.

The Operator Guidance System runs on standard computers and can be integrated easily in higher-level ERP systems. In addition to hand-held nutrunners, you can also flexibly integrate other peripheral devices, such as torque wrenches, scanners, socket trays or pick-to-light systems. The assistance system supports automotive-specific protocols and data output in conventional formats. The system detects errors immediately and gives direct instructions on how to correct them. It visualizes every process step, including all manual processes. This allows you to achieve maximum process reliability and transparency in your assembly.



SUPPORTED FUNCTIONS

- ▶ One active tool per station at a time
- ▶ Component hierarchy: component, operation, job
- ▶ Pre-tightening, final tightening, manual clicking
- ▶ Preset or freely selectable tightening sequence
- ▶ Selection of component, operation and job by means of bar code or PLC
- ▶ Tool selection by means of socket trays
- ▶ Pick-to-light via Modbus-TCP/UDP
- ▶ Interruption and resumption of processing sequences
- ▶ Flexible interfaces for ID codes and result data output

HARDWARE REQUIREMENTS

- ▶ Standard PC (i3 CPU, 4 GB RAM, 128 GB SSD, full HD (1080P) Monitor, Windows 10)
- ▶ Touch operation possible

SCOPE OF FUNCTIONS –

INTERFACES AND EXPANSION OPTIONS

- ▶ 4.0 interfaces (SignalR and MQTT)
- ▶ Driver interface for tightening systems
- ▶ CS/KE (PROFIBUS) and open protocol (Nexo cordless nutrunner)
- ▶ Torque wrench (e.g. SCS)
- ▶ Socket tray (USB/Lan/Wifi/PROFIBUS/PROFINET)
- ▶ Worker identification
- ▶ Position visualization and determination of the order of the tightening positions
- ▶ Modbus-TCP, e.g. pick-to-light
- ▶ Lua-Scripting for flexible adaptations
- ▶ Data output interfaces
- ▶ XML file (“Motis”), text file (“Csv”)
- ▶ Export/archiving from local database

Rexroth Service – the Original!

Your experts for controlled tightening technology



As a full provider of electrical tightening systems, Bosch Rexroth not only offers an extensive product portfolio and individual customer solutions, but also a varied range of worldwide services.

Rexroth's tightening technology service supports you with tailor-made services in accordance with individual specifications and specific quality standards. It does so in a fast, professional, and reliable manner. Rexroth supports end users and machine manufacturers over the entire life cycle of their machines and systems. In order to ensure the long-term availability and efficiency of tightening systems used in the field, the Rexroth repair service repairs and maintains them in an OEM quality level. Optionally they can happen as a standard, urgent, or rush job.

You need support with optimizing your tightening processes? You have questions about retrofit and upgrade options? No problem. Our experienced service experts look forward to offering you a consultation.

The qualification of your employees is a key and an indispensable element to gain crucial advantages in the global competition. As one of the world's leading specialists, Rexroth has a deep technological know-how. The Rexroth Service conveys this expertise as part of basic and hands-on product training sessions. In addition, training courses tailored to your individual needs and requirements ensure effective and sustainable learning and further knowledge for your employees. This can happen at Rexroth training sites or directly in your factory.

WORLDWIDE SERVICE

Our global service network can be reached at any time in over 40 countries. You can find detailed information on service locations on the Internet at:

www.boschrexroth.com/service.

SERVICE PORTFOLIO

- ▶ Consulting
- ▶ Training
- ▶ Fieldservice
- ▶ Spare parts management
- ▶ Repair service
- ▶ Product overhaul
- ▶ Maintenance
- ▶ Machine capability analysis
- ▶ Measuring transducer test
- ▶ Re-use
- ▶ Modernization

Additional information on Rexroth's tightening technology service can be found at **www.boschrexroth.com/tightening**



Customized, future-proof production with Rexroth Assembly Technology

Working environments are all the more efficient when they are individually tailored to meet the respective production requirements. From flow racks and frames made of aluminum profiles, enclosures, ergonomic assembly work stations through to fully automated manufacturing lines with transfer systems: Based on decades of practical experience, the sophisticated and uniquely versatile assembly technology from Bosch Rexroth is continuously being further developed. With modular, finely coordinated components, Bosch Rexroth facilitates the realization of customized, future-proof solutions for your production.



Further information on Assembly Technology products can be found in the corresponding catalogs at the Rexroth Media Directory:
www.boschrexroth.com/mediadirectory

Assembly Technology

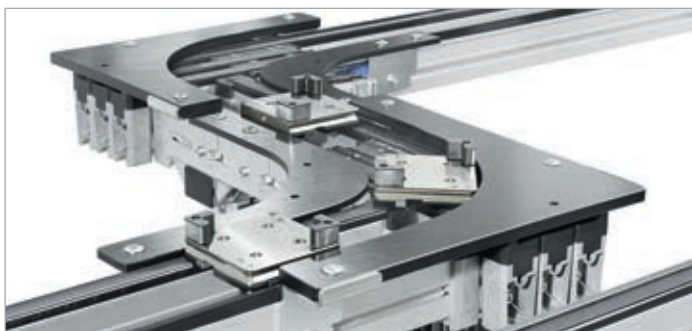

TRANSFER SYSTEM TS 1

Weight class: 0–3 kg

Workpiece pallet sizes: 80 x 80 up to 160 x 160 mm

The TS 1 transfer system is specifically tailored to small, lightweight products and assemblies, which require high positioning accuracy and repeatability.

Catalog	3842528596
---------	------------

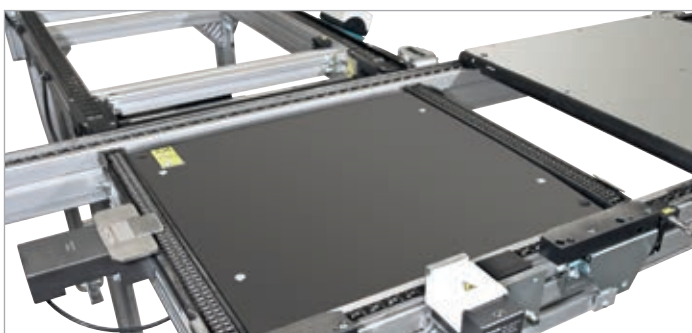

TRANSFER SYSTEM TS 2plus

Weight class: 0–240 kg

Workpiece pallet sizes: 160 x 160 up to 1,200 x 1,200 mm

From the automotive industry and the electronics industry to household appliances and electronics manufacturing: With their diverse system components, TS 2plus assembly lines are suitable for use in a wide range of industries.

Catalog	R999000395
---------	------------

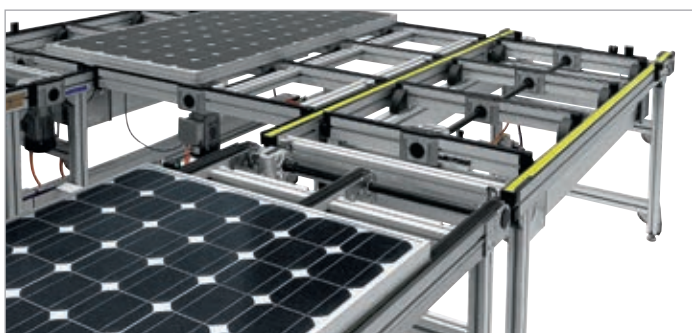

TRANSFER SYSTEM TS 2pv

Panel weight: 0–120 kg

Panel sizes: 0–2,200 mm edge length

The transport system TS 2pv was developed as a tailor-made solution for the solar industry. Photovoltaic modules in both thin-film and silicon cell technology can be transported directly.

Catalog	3842540431
---------	------------



TRANSFER SYSTEM TS 5

Weight class: 0–< 400 kg

Workpiece pallet sizes: 455 x 455 up to 1,040 x 845 mm

The roller conveyor TS 5 conveys loads of up to 400 kg or more even over long distances and its robust construction make it especially suitable for harsh and oily environments.

Catalog	3842540379
---------	------------

Assembly Technology



LINEAR MOTOR-DRIVEN TRANSFER SYSTEM

ActiveMover

Weight class: 0–10 kg (depending on number of magnets)
If products have to be transported particularly quickly and precisely. The workpiece pallets accelerate with up to 4 g and achieve an extremely high dynamic. ActiveMover covers is used e.g. in electronics production, the automotive supply industry, medical technology and life sciences.

Catalog

R999001426



RFID SYSTEMS

RFID systems ensure the flow of information accompanying goods in the assembly lines. Object-related data enable the targeted control of process and processing steps, as well as the type- or variant-dependent inward and outward transfer of workpiece pallets during the production of product variants on branched, flexible assembly systems. By documenting all process steps and production data, traceability when errors occur is also possible.

All RFID systems from Rexroth are read/write systems and support common fieldbuses. They are perfectly matched to the transfer systems and the VarioFlow chain conveyor system.

Catalog

3 842 541 003



CHAIN CONVEYOR SYSTEM VarioFlow plus

Chain tension: up to 1,250 N (ESD 600 N)
Track width: 65/90/120/160/240/320 mm

With VarioFlow *plus*, Rexroth offers you a versatile, high-performance and standardized conveyor system for use in the fields of food and packaging, health care, automotive and electronics assembly lines and machine interlinking.

Catalog

R999000401



BASIC MECHANIC ELEMENTS

Bosch Rexroth offers you decades of experience and unbeatable flexibility when designing your assembly line – with the world’s largest aluminum profile building system. The robust and corrosion-resistant Rexroth profiles allow you to realize components such as ergonomic work tables, flow racks, or protective fences within a short time and without having to spend great effort on planning.

Catalog	3842540391
----------------	-------------------



MANUAL PRODUCTION SYSTEMS

Based on the three pillars of the Manual Production Systems covering workstations, material supply and linking, you can create, for example workstations, as well as entire production lines, that can be quickly adapted to your work content and executed in an extremely efficient manner and avoiding waste in line with „lean“ principles.

Catalog	3842538280
----------------	-------------------

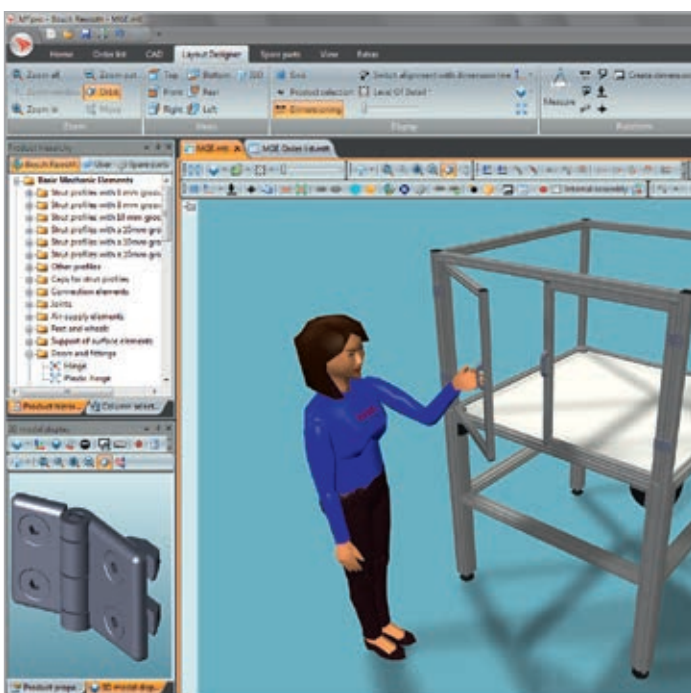

MTpro – PLANNING SOFTWARE

This especially user-friendly software speeds up and simplifies the planning of application-specific frames, enclosures and workstations. Unlimited combination options together with simple planning and ordering as well as excellent adherence to deadlines allow you to achieve perfect results. The entire ordering process can also be done in next to no time. The data can be transferred to your CAD or VR (Virtual Reality) environment via a CAD interface.

The program offers the following functions and full content in seven languages (en/de/fr/es/it/ja/zh):

- ▶ Complete product information
- ▶ CAD library
- ▶ Quick & Easy configurator
- ▶ Profile deflection calculation
- ▶ Conversion of profile drawings
- ▶ Quick and simple planning in the layout designer

Catalog	3 842 539 057
----------------	----------------------

Rating of a tightening connection

The basic value for the rating of a tightening connection is the clamp force required to ensure the functioning of the tightening connection. Clamp force F_k must always be greater than the acting force F_A to be expected in operation ($F_k > F_A$).

The maximum number of bolts and their maximum thread value result from the design conditions, i.e. the space available for the bolts. A maximum permissible force of F_{max} can be calculated taking into consideration the stress cross-section of the bolt and the number of bolts. With currently available technology it is not possible to directly measure the clamp force (pretensioned force) during the tightening process. Therefore, it is necessary to rely on torque and angle of turn instead.

Especially in the case of torque-controlled tightening processes the clamp force is strongly influenced by the friction under the bolt head and in the threads. A tightening connection should be designed so that the minimal attainable pretensioned force F_{Mmin} guarantees the functioning of the tightening connection, but the maximum pretensioned force F_{Mmax} does not destroy the tightening connection or bolt. In order to be able to make a statement as to how the cited values will affect the mounting clamp force, the tightening factor $\alpha A = \frac{F_{Mmax}}{F_{Mmin}}$ was established in VDI 2230.

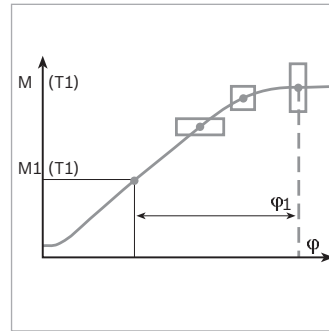
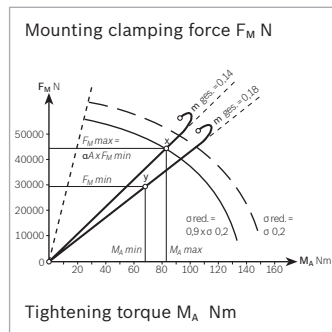
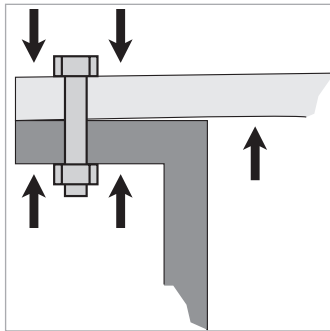

Example:
M10 DIN 912-12 $g \mu$ total = 0.14 – 0.18

Clamping force table according to VDI 2230

Abm.	Prop. class	Mounting clamp forces $F_{M Tab}$ in kN for $\mu_G =$							Tightening torques M_A in Nm for $\mu_K = \mu_G =$						
		0.08	0.10	0.12	0.14	0.16	0.20	0.24	0.08	0.10	0.12	0.14	0.16	0.20	0.24
M4	8.8	4.6	4.5	4.4	4.3	4.2	3.9	3.7	2.3	2.6	3.0	3.3	3.6	4.1	4.5
	10.9	6.8	6.7	6.5	6.3	6.1	5.7	5.4	3.3	3.9	4.6	4.8	5.3	6.0	6.6
	12.9	8.0	7.8	7.6	7.4	7.1	6.7	6.3	3.9	4.5	5.1	5.6	6.2	7.0	7.8
M5	8.8	7.6	7.4	7.2	7.0	6.8	6.4	6.0	4.4	5.2	5.9	6.5	7.1	8.1	9.0
	10.9	11.1	10.8	10.6	10.3	10.0	9.4	8.8	6.5	7.6	8.6	9.5	10.4	11.9	13.2
	12.9	13.0	12.7	12.4	12.0	11.7	11.0	10.3	7.6	8.9	10.0	11.2	12.2	14.0	15.5
M6	8.8	10.7	10.4	10.2	9.9	9.6	9.0	8.4	7.7	9.0	10.1	11.3	12.3	14.1	15.6
	10.9	15.7	15.3	14.9	14.5	14.1	13.2	12.4	11.3	13.2	14.9	16.5	18.0	20.7	22.9
	12.9	18.4	17.9	17.5	17.0	16.5	15.5	14.5	13.2	15.4	17.4	19.3	21.1	24.2	26.8
M7	8.8	15.5	15.1	14.8	14.4	14.0	13.1	12.3	12.6	14.8	16.8	18.7	20.5	23.6	26.2
	10.9	22.7	22.5	21.7	21.1	20.5	19.3	18.1	18.5	21.7	24.7	27.5	30.1	34.7	38.5
	12.9	26.6	26.0	25.4	24.7	24.0	22.6	21.2	21.6	25.4	28.9	32.2	35.2	40.6	45.1
M8	8.8	19.5	19.1	18.6	18.1	17.6	16.5	15.5	18.5	21.6	24.6	27.3	29.8	34.3	38.0
	10.9	28.7	28.0	27.3	26.6	25.8	24.3	22.7	27.2	31.8	36.1	40.1	43.8	50.3	55.8
	12.9	33.6	32.8	32.0	31.1	30.2	28.4	26.6	31.8	37.2	42.2	46.9	51.2	58.9	65.3
M10	8.8	31.0	30.3	29.6	28.8	27.9	26.3	24.7	36	43	48	54	59	68	75
	10.9	45.6	44.5	43.4	42.2	41.0	38.6	36.2	53	63	71	79	87	100	110
	12.9	53.3	52.1	50.8	49.4	48.0	45.2	42.4	62	73	83	93	101	116	129
M12	8.8	45.2	44.1	43.0	41.9	40.7	38.3	35.9	63	73	84	93	102	117	130
	10.9	66.3	64.8	63.2	61.5	59.8	56.3	52.8	92	108	123	137	149	172	191
	12.9	77.6	75.9	74.0	72.0	70.0	65.8	61.8	108	126	144	160	175	201	223
M14	8.8	62.0	60.6	59.1	57.5	55.9	52.6	49.3	100	117	133	148	162	187	207
	10.9	91.0	88.9	86.7	84.4	82.1	77.2	72.5	146	172	195	218	238	274	304
	12.9	106.5	104.1	101.5	98.8	96.0	90.4	84.8	171	201	229	255	279	321	356
M16	8.8	84.7	82.9	80.9	78.8	76.6	72.2	67.8	153	180	206	230	252	291	325
	10.9	124.4	121.7	118.8	115.7	112.6	106.1	99.6	224	264	302	338	370	428	477
	12.9	145.5	142.4	139.0	135.4	131.7	124.1	116.6	262	309	354	395	433	501	558
M18	8.8	107	104	102	99	96	91	85	220	259	295	329	360	415	462
	10.9	152	149	145	141	137	129	121	314	369	421	469	513	592	657
	12.9	178	174	170	165	160	151	142	367	432	492	549	601	692	769
M20	8.8	136	134	130	127	123	116	109	308	363	415	464	509	588	655
	10.9	194	190	186	181	176	166	156	438	517	592	661	725	838	933
	12.9	227	223	217	212	206	194	182	513	605	692	773	848	980	1092
M22	8.8	170	166	162	158	154	145	137	417	495	567	634	697	808	901
	10.9	242	237	231	225	219	207	194	595	704	807	904	993	1,151	1,284
	12.9	283	277	271	264	257	242	228	696	824	945	1057	1162	1,347	1,502
M24	8.8	196	192	188	183	178	168	157	529	625	714	798	875	1,011	1,126
	10.9	280	274	267	260	253	239	224	754	890	1,017	1,136	1,246	1,440	1,604
	12.9	327	320	313	305	296	279	262	882	1,041	1,190	1,329	1,458	1,685	1,877
M27	8.8	257	252	246	240	234	220	207	772	915	1,050	1,176	1,292	1,498	1,672
	10.9	367	359	351	342	333	314	295	1,100	1,304	1,496	1,674	1,840	2,134	2,381
	12.9	429	420	410	400	389	367	345	1,287	1,526	1,750	1,959	2,153	2,497	2,787

Guide values for clamp forces (FM) and tightening torques (MA) for headless bolts with metric coarse-pitch threads according to DIN ISO 262 and head dimensions

for hexagon bolts according to DIN EN ISO 4014 to 4018 or fillister head bolts according to DIN EN ISO 4762, and "central" hole according to DIN EN 20 273.

Glossary

Output drive	Spindle components that include the tightening tool (e.g. tightening nut).	Gradient	Inclination of a tangent in the torque/ angle of turn graph.
Multiple connections	Minimum permissible distance between the tightening positions.	Handling device	Manually-operated, hand-held tightening modules which the worker uses to approach the tightening position and carry out the tightening operation without exerting any force. Depending on the design, the handling device can also support the reverse torque (reaction torques).
Working range	Permissible torque range of tightening spindle/ErgoSpin/Nexo.	IEC 61131-3	Internationally recognized standard for programming languages of programmable logic controllers.
Size (BG)	Tightening spindles are available in sizes 2 – 5, the sizes cover different working ranges.	Max. output drive speed	Defined by the interaction of EC motor, planetary gearbox and output drive.
Block output drive	Single housing combines multiple output drive spindles for tight bolt patterns.	Measurement transducer	Spindle component that analyzes the torque, angle, and gradient and is equipped with an integrated cycle counter.
DVI	Digital Visual Interface – interface for the digital transfer of video data.	Redundant Measurement transducer	At least two independent measurement transducers that continually record the same parameters.
I/O	Input/output – I/O are discrete interfaces for sending and receiving digital signals.	Center-to-center distance	See multiple connections.
EC motor	Electronic Commutated motor – a brushless, and thus maintenance-free, motor.	Tightening case analysis	Analysis of torque and angle-of-turn measurements taken during tightening, on the basis of which conclusions about the tightening process and the quality of the tightening connection can be made.
ErgoSpin	Hand-held nutrunner from Rexroth with tool cable.	Tightening channel	Includes all components required for a tightening job: tightening spindle or ErgoSpin hand-held nutrunner, connection cable, as well as control and power electronics.
Spring force	The spring force of an output drive describes the force required to completely compress (F_{max}) the pre-tensioned spline shaft (F_{min}) of an output drive.	Tightening program	Controls the tightening process and is divided into various tightening steps, where tightening parameters are set.
Range of spring	Travel output which results from engaging the tightening module and tightening until the screw-in depth is reached.		
Crowfoot wrench	Special components designed for very tight and hard-to-reach tightening positions.		
Spindle bearing	Output drive component with straight spline shaft which supports the tightening tool (e.g. tightening nut).		

Tightening spindle	Comprises an output drive unit, measurement transducer and a gearboxmotor combination for the drive and is used with hand-held and automatic tightening tasks.	Offset output drive	Output drive component for tight center to center distances where the spline shaft and drive unit are offset.
Tightening station	Hand-held, manually-operated, or automatic tightenings are carried out on a tightening station. It can be a part of an assembly line.	Feed output drive	Output drive component for deep-seated tightening positions (e.g. motor plugs).
Tightening position	Refers to the defined location where the tightening job is performed using a tightening channel and a tightening program.	Tool mount	Interface between the tightening spindle and tool. For example, a square is a typical tool mount for a tightening nut as a tool.
Tightening system	A complete system with all of the tightening channels that are needed to carry out the defined tightening case. It communicates with a superior controller.	Angle head	Output drive components which are used from above, usually on the hand-held nut-runner, if there is limited space available (e.g. inner housing tightening).
IP54 protection class	Suitability of components for certain ambient conditions, e.g. for industrial systems. IP54 refers to the protection against splash water and dust.	Feed gripper	Component used to store and supply bolts to the tightening tool.
Socket tray	Container for various tool inserts. Corresponding tightening programs are activated when the tools are removed		
Controllers	Controls and monitors the tightening process or exchanges data with superior controllers.		
System Stick	A USB stick included in the scope of delivery that contains, among other things, the installation program for the BS350 Operating System and the system documentation.		
Avg. efficiency	Quotient calculated from output drive performance and drive performance. The output drive performance and drive performance depend on the speed and torque, which is why efficiency is not constant.		

Bosch Rexroth AG

Fornsbacher Straße 92
71540 Murrhardt, Germany
www.boschrexroth.com/tightening

Questions?

Contact our tightening experts:

rfq.jt@boschrexroth.de

Further information online:



Online Product Catalog

Besides of the CAD data, here you can find the firmware service packs for downloading:
www.boschrexroth.com/tightening



Rexroth Media Directory

Here is your 24/7 source for promotional media and technical documentation. Search and download information:
www.boschrexroth.com/mediadirectory

© This document and the data, specifications and other information contained therein are the exclusive property of Bosch Rexroth AG. Reproduction or transfer to third parties is not permitted without their consent.

The data specified above only serve to describe the product. As our products are constantly being further developed, no statements concerning a certain condition or suitability for a certain application can be derived from our information. The information given does not release the user from the obligation of own judgment and verification. It must be remembered that our products are subject to a natural process of wear and aging.

Document no.: 72804
Material no.: R999000049 (2018-11)
© Bosch Rexroth AG 2018
Subject to revisions!
Printed in Germany





Tightening Systems